

Engineer

INNOVATION

Issue 3

In this issue

Lion Electric co.:
Battery design for
electric school bus
Page 4

ABEC: Bioreactor
scaleup and
platform designs
Page 10

Ural Locomotives:
Reduce time-to-
manufacture by 40%
Page 30

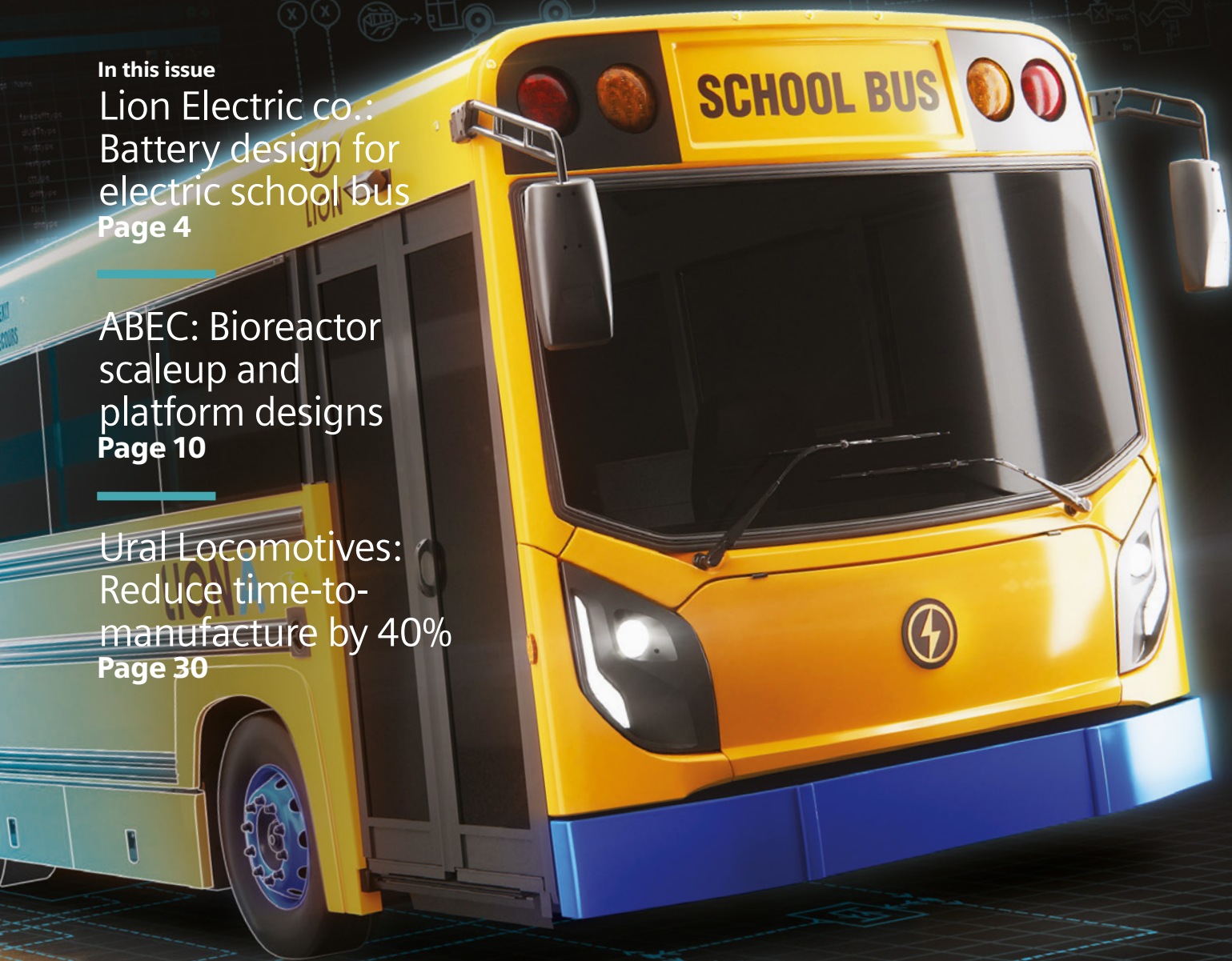

SIEMENS

Ingenuity for life

[siemens.com/simcenter](https://www.siemens.com/simcenter)



Next stop... Innovation!



Siemens PLM Software

Jan Leuridan
Senior Vice President
Simulation and Test Solutions

It is always a pleasure to read success stories from our customers, and this issue is no different. The theme emerging from this collection that struck a chord with me is how many of our customers are seeking to improve our day-to-day lives.

The Lion Electric bus company used Simcenter to help them design their fleet of electric vehicles used in particular for mass transit. The new electric-motor school buses are more reliable and less polluting than their ICE counterparts; ensuring students not only get to school on time but do so in cleaner air. DMS Holland working with their partners at Brabant Engineering, have developed more effective marine stabilisers to help reduce the motion that induces seasickness making time afloat more pleasurable in even small craft.

URAL Locomotives in Russia worked with a suite of Siemens products

including Simcenter to bring an all-electric train to the rails in less than three years. This was against the backdrop of incredibly tough operating conditions from the tropical to the frozen north of Russia. This reduces not only travel time but emissions. All achieved without any physical tests.

The adoption of a digital twin approach continues to grow and our customers in this issue demonstrate how they use the method to reduce prototyping, gain real-world insight and improve the collaboration between simulation and test.

The Simcenter portfolio continues to develop to reflect the demands of industry and we add Electromagnetic functionality to our Simcenter 3D solution to help engineers manage this increasingly complex area of physics.

I hope to meet you all at our Simcenter Conference in December. ■

Contents



Engineer Innovation

- 4 COVER: Lion Electric co. Battery design for electric school bus
- 8 Optimizing model-based system testing
- 10 ABEC: Bioreactor scaleup and platform designs
- 16 Brabant Engineering: Designing an innovative marine stabilizer system
- 24 Xilinx, Inc.: Validation of Packaging Thermal Resistance
- 26 Nissan Technical Centre Europe: Implementing end-to-end solutions for test-based durability engineering
- 30 Ural Locomotives: Reduce time-to-manufacture by 40%

- 38 E2M Technologies: Global simulator designer and manufacturer adopts Simcenter to speed up product development
- 40 BAR Ben Ainslie Racing Technologies: New class of sport yachts
- 46 Rate shaping the future
- 50 KAERI: Design of a sodium-water reaction pressure relief system
- 52 BSH: Optimizing acoustics and vibration product testing with Simcenter Testlab
- 56 High channel-count dynamic measurements
- 58 asa hydraulik: Verify and optimize thermal system designs
- 62 How electromagnetics engineering surrounds us

Regular Features

- 22 Interview: Guy Wagner, eCooling Solutions Inc.
- 36 How To... Set up and calibrate after-treatment system models
- 66 Geek Hub
- 68 Brownian Motion

Lion Electric

Electric school bus manufacturer uses Simcenter Amesim for system simulation to optimize battery design and thermal management

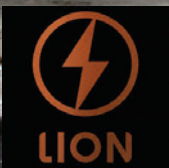

Siemens Digital Industries Software solution enables Lion Electric to deliver a more reliable product at the start of production

Seeking more sustainable urbanization

According to the United Nations, urbanization is growing rapidly. By 2030, the world is projected to have 41 megacities with 10 million or more inhabitants. More people means more cars on the road and more air pollution as transportation represents one-third of pollutant emissions. It also means there is a limit to the number of cars the infrastructure will be able to accommodate, which is why it is so important to develop sustainable mass transportation solutions.

That's one of the reasons why the leaders from the world's largest cities, representing 650 million people, decided to create the C40 Cities Climate Leadership Group to tackle climate change and drive urban action that reduces greenhouse gas emissions and congestion. They are pledging to procure only zero-emission buses by 2025, which they hope will lead to green and healthy "fossil-fuel-free streets."

Enhancing the overall quality of life

From its founding in 2011, the goal of the Lion Electric Co., has been to provide sustainable public transportation. The firm, which is headquartered in Saint-Jérôme, Quebec, Canada, designs, engineers and manufactures all-electric school buses, midi/minibuses for special needs and urban transit as well as urban trucks. The firm believes transitioning to all-electric vehicles will lead to major improvements in our society, environment and overall quality of life.

Taking on new engineering challenges in product development

Developing an electric-powered bus presents new and challenging engineering considerations, such as the thermal management of the battery as

well as its integration into the overall vehicle. Raphael Ouellet, who is the powertrain product engineer on the Lion Electric engineering team, explains expectations are set at two levels: "First, in the case of a battery-powered vehicle, a subsystem analysis is required to have a precise view on how the drive cycles and charging scenarios would affect the battery's capability to develop the appropriate thermal management solutions, and identify coolant-flow balancing in cooling-heating loops to optimize overall thermal management. Secondly, from early development at the vehicle level we expect to be able to assess the overall vehicle performance over real drive cycles in order estimate a realistic range."

Rapidly developing a robust electric powertrain

These considerations need to be understood at the beginning of the product development process. This enables Lion Electric to avoid recalls at the start of the production because of design errors, which could affect the safety of the vehicle but also implies additional costs and increased time-to-market. Then, to develop a battery and assess its performance once integrated into the complete vehicle early in the development cycle, the Lion Electric engineering team chose Siemens Digital Industries Software's Simcenter™ Amesim™ system simulation software.

Lion Electric started from scratch modeling its battery design and thermal management. They were initially supported by Maya HTT, an engineering service company, who provided support and expertise to model the battery and help Lion through the iteration process until an optimized solution was found. They started designing the cells and all the thermal exchanges of the cells first with the aluminum box, and then within the overall environment of the battery.

"Using Simcenter Amesim to reproduce the thermal exchanges within the battery and the forced-air cooling

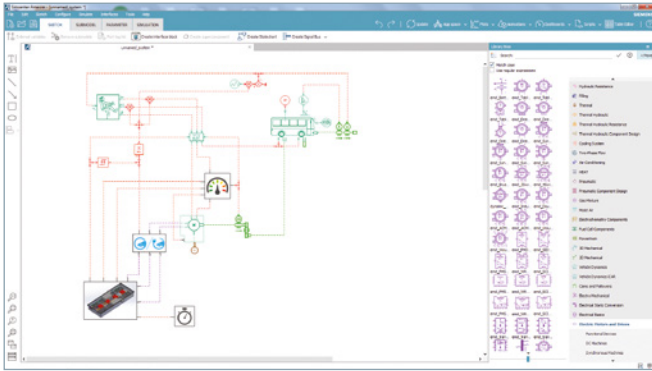

Figure 1: Simcenter Amesim vehicle model

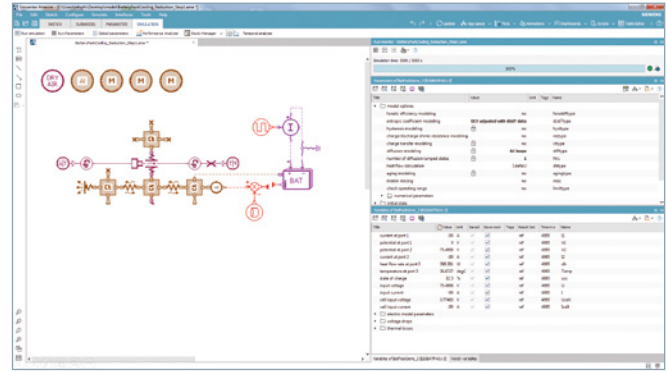

Figure 2: Simcenter Amesim battery model

“Using Simcenter Amesim allowed us to make the right decisions from the start and optimize time-to-market.”

Raphael Ouellet
Powertrain Product Engineer
Lion Electric Co.

enabled us to define the best architecture for all the elements of the battery,” explains Ouellet. “Maya HTT provided the guidance we needed to find the right architecture.”

The battery’s open circuit voltage and internal resistance curves were identified in just a few clicks from the supplier’s datasheet using the three batteries datasheet import application.

Once the battery had been designed, Lion Electric tested the performance of its physical twin in a climate-controlled room to adjust the digital model against the results. Thanks to the testing phase, the accuracy of the model was improved in terms of electrical performance and heat rejection.

“Using Simcenter Amesim allowed us to make the right decisions from the start and optimize time-to-market,” says Ouellet. “We are also able to run simulations for clients and offer them

details about the expected range or expected payload for a specific use case.”

User-friendly software that facilitates efficient reporting

Lion Electric’s satisfaction with Simcenter Amesim is reinforced by how easy it is to use and create reports. Indeed, Ouellet explains, “Simcenter Amesim™ helps us produce graphs and reports quickly, building presentations in no time. Also, many more variables can be considered compared to using spreadsheets calculations, which allows us to produce more refined results. Reruns are easy, so when my management requests modifications, I can quickly implement them.”

“Simcenter Amesim has many benefits: The intuitive interface, powerful and optimized algorithms, the ease-of-use of data management (visualization, postprocessing, global parameters, etc.) and implemented tools (optimization,



Figure 3: All-electric Urban Class 8 truck

3D visualization, etc.) enable us to save time to provide top management and customers with easy-to-understand results.”

Realizing lower production costs

“We have the same amount of time to develop our model, and by replacing spreadsheet software with Simcenter Amesim, we now can improve our battery performance assessment and go deeper into details for our analysis,” says Ouellet. “This same amount of time is then spent on developing, optimizing and building the most appropriate battery architecture and related thermal management. This allows us to bring a more reliable and mature product at the start of production.

“Overall, we believe this approach leads to lower product development costs. Indeed, if we have to modify a product after production has started, it can be very costly. Recalls covering design errors affecting the safety of the vehicle is an original equipment manufacturer (OEM) nightmare, and we all work hard to avoid that.”

The time and cost saved thanks to the use of simulation enables Lion Electric to start looking for upcoming technologies. Ouellet explains, “When production on vehicles start, we are already looking for ways to improve the systems for future generations. Efficiency is something that can always be optimized. Also, we control every aspect of our designs, making much better products than companies that electrify other companies’ chassis and vehicles.” ■

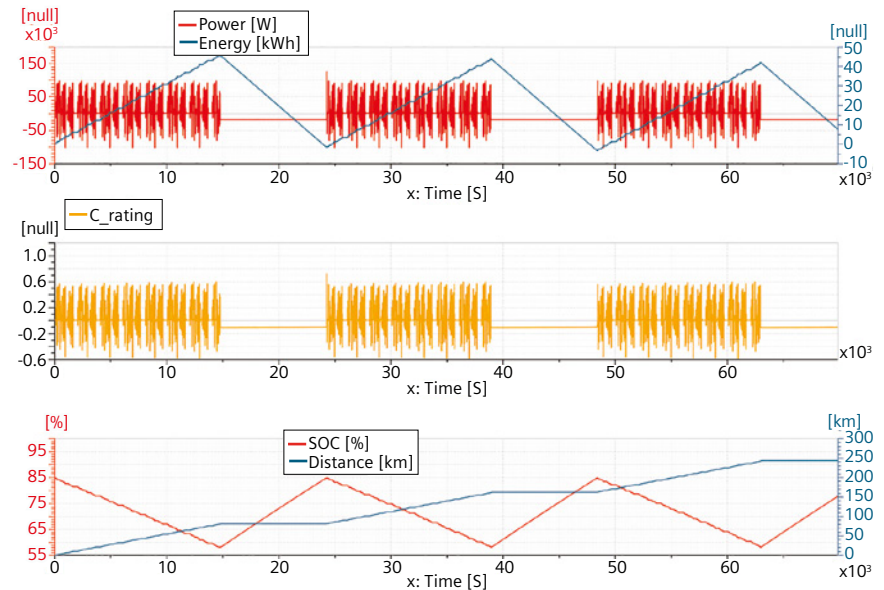

Figure 4: Battery cycle profile in Simcenter Amesim



Figure 5: Electric mini school bus

“Using Simcenter Amesim to reproduce the thermal exchanges within the battery and the forced-air cooling enabled us to define the best architecture for all the elements of the battery.”

Raphael Ouellet
Powertrain Product Engineer
Lion Electric Co.

Model-based system testing

Optimizing complex systems by combining physical prototypes and simulation models throughout the development cycle.

To cope with market demands for energy efficiency, active safety systems, mass customization and high performance, new generations of vehicles include an ever-increasing amount of mechatronics. Established manufacturers need to continuously rethink processes and reassess development activities. The classic verification-centric engineering approaches with separate workflows for test and simulation require many iterations and lack the necessary efficiency and flexibility to successfully handle current product complexity. Model-based system testing (MBST) exploits the synergies of combining test and simulation throughout the development cycle. Using MBST helps test and simulation engineers successfully perform the attribute engineering of vehicle systems and subsystems. Using MBST ensures productivity of, and provides detailed engineering insights into, a model-based development (MBD) approach.

The complexity, innovation and personalization of car design means there are more variants, components and systems, as well as increasingly innovative design exploration and attention to quality issues. As the complexity of cars increases, it is highly inefficient to repeatedly create and test physical prototypes to validate designs and solve problems. Instead, predictive methods are rapidly gaining ground. Over the last decades, the speed and fidelity of simulation solutions have drastically improved. Modern multibody simulation software can simulate realistic scenarios for systems composed of hundreds of



flexible bodies within an hour. State-of-the-art system simulation solutions can accurately simulate the multi-physical nature of systems by embedding all relevant physical phenomena (mechanics, electrics, hydraulic, pneumatics, etc.) in one solver. Although simulation has become the centerpiece of any engineering approach, real measured data is more important than ever for confirming modeling accuracy and completing the models, especially when exploring uncharted design areas. Testing remains essential to identify model parameters to provide realistic model inputs and validate numerical models.

To efficiently master system engineering complexity during product development and be successful as a team, test and simulation engineers need to align their workflows and exploit synergies they create by combining their tools. This keeps the product development cycle as short as possible and brings consistency to the processing of system data throughout the development cycle.

MBST validates functional performance using proven analytics and can be leveraged at any stage of design to consistently perform attribute engineering on virtual models, combined virtual-physical systems and physical prototypes.

The combined use of test and simulation can be categorized in three main categories: (1) Testing for simulation, (2) testing with simulation and (3) simulation for testing.

Testing for simulation covers a wide range of approaches in which measured data is used to endorse modeling accuracy. Test data is primarily used to build, validate, improve and drive simulation models. The delivery of ultrarealistic, multiphysics models for systems engineering is the final goal.

In the second category, testing with simulation, the physical and virtual worlds interact, complementing each other. This approach is of interest for

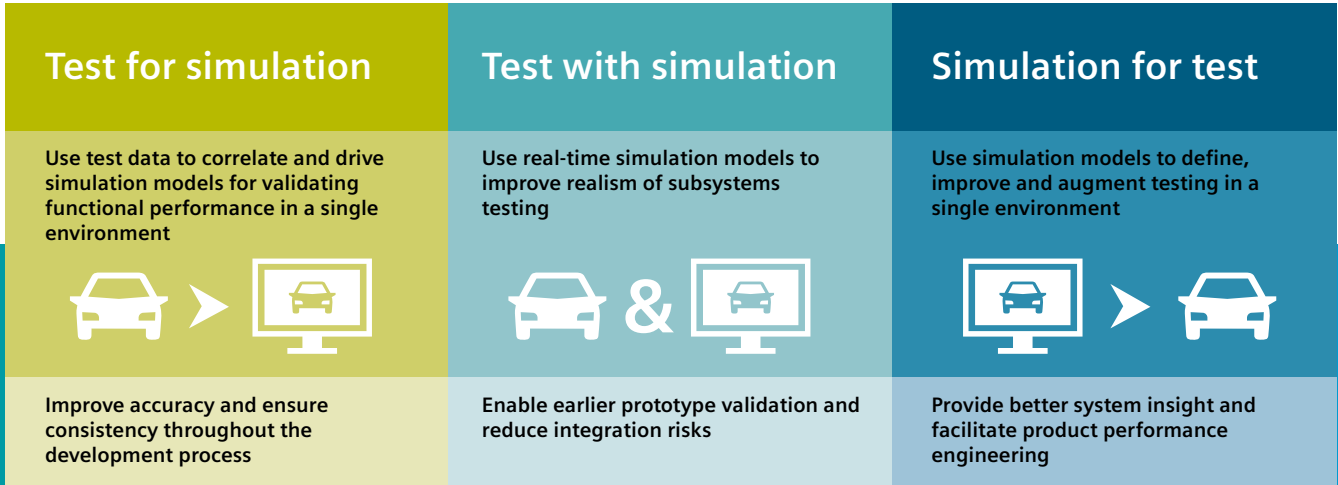

testing in conventional or real-time, and experimentally optimizing subsystem behavior in the context of a virtual system integration. These applications require modeling approaches and testing procedures that fulfill several new requirements when compared to pure simulation, or testing for isolated design engineering tasks.

Simulation for testing uses simulation models to define, validate and complement testing procedures and test data. Virtual sensing is an emerging field for testing simulation models when they are fused with a limited set of experimental data to estimate system variables that are difficult or costly to measure directly (for example, inaccessible location, inaccurate direct measurements, or no existing sensor). Virtual sensing enriches the measurement dataset, thus providing better insight for engineers who are testing the system. Accurate models are required as a starting point (often obtained through test-based-updating approaches). State estimators are then used to fuse test and simulation data and ensure optimal data quality.

Simcenter software from Siemens Digital Industries Software provides a unique environment for performance engineering of mechatronic systems. Simcenter model-based system testing integrates system simulation and testing tools, while extending its capabilities to include model-based, real-time testing.

Siemens' next-generation software suite, Simcenter Testlab™ Neo software, is well

sued for MBST, providing capabilities for data collection, visualization, post-processing, reporting and modeling. It leverages Simcenter™ SCADAS™ hardware to acquire multiphysics data from an extensive range of sensors. Its novel Sketch Viewer provides direct model-driven access to Simcenter Amesim software models and data, and seamlessly integrates 1D modeling with Simcenter SCADAS measurements. Simcenter™ Testlab™ Neo Process Designer provides powerful postprocessing capabilities for test and simulation models. Along with Simcenter Amesim models, Process Designer offers engineers the ability to embed one or multiple Functional Mockup (FMU) models created by any tool supporting the Functional Mockup Interface (FMI) 2.0 standard. Process Designer then runs these simulation models as part of an analysis process, using measurement data for input and providing validation

on-the-fly. This approach can be used for validating and updating model parameters, calculating model-based virtual channels or sensors and performing health checks on physical sensor instrumentation.

Simcenter model-based system testing solutions provide consistency in the tools and methods used all along the development cycle, creating a more agile mechatronic system development process and enabling you to test early physical prototypes of mechatronic systems in simulated, near real-life operating conditions.

Within Simcenter Testlab™ 2019.1, Siemens introduces novel functionalities that bring the concept of model-based testing to life, providing full-system performance validation based on combined physical and virtual testing during any stage of development. ■

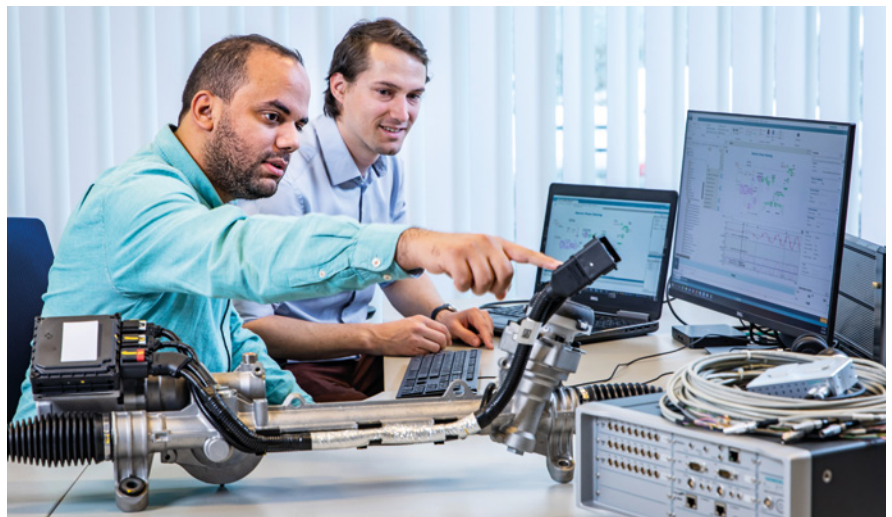



Biopharmaceutical manufacturer uses Simcenter STAR-CCM+ to reduce blend time by 50 percent

Siemens Digital Industries Software solution helps ABEC to reduce risk, time-to-market and cost while ensuring product quality

From lab scale to industrial scale

Every medicine ever developed started out in a lab, developed and tested in small batches until it was ready to be produced in large quantities. Although not unique to the pharmaceutical industry, the challenges of scaling up from lab-scale experiments to industrial-scale production are critical given the nature and intended use of the products. Scaleup is one of challenges that ABEC has been dealing with since its inception over 40 years ago when it joined the marketplace as a supplier of bioreactors and fermenters. In many ways, their timing couldn't have been better as major advances in cell culture and biotechnology were just emerging.

ABEC has been providing engineering, equipment and services to the biopharmaceutical industry throughout the world since 1974. Founded by Jack Wilson, ABEC provides custom-engineered solutions to the life science industry, supporting their efforts to create life-changing therapies. The company provides a range of engineering solutions for manufacturing therapeutics.

Since its inception, ABEC has enhanced its capabilities as technological advances became available. At the beginning, customer systems were being operated

manually. ABEC initially helped its customers to automate their processes to achieve reproducible performance. Today it provides harvest, recovery and concentration capabilities, benefitting its customers by supporting the entire bioprocess. The company provides extensive aftermarket service and support, process consulting, equipment

upgrades, maintenance services and customer training.

A majority of the world's pharmaceutical and biotech companies are customers of ABEC, and more than 3,000 of the company's systems are in use worldwide.

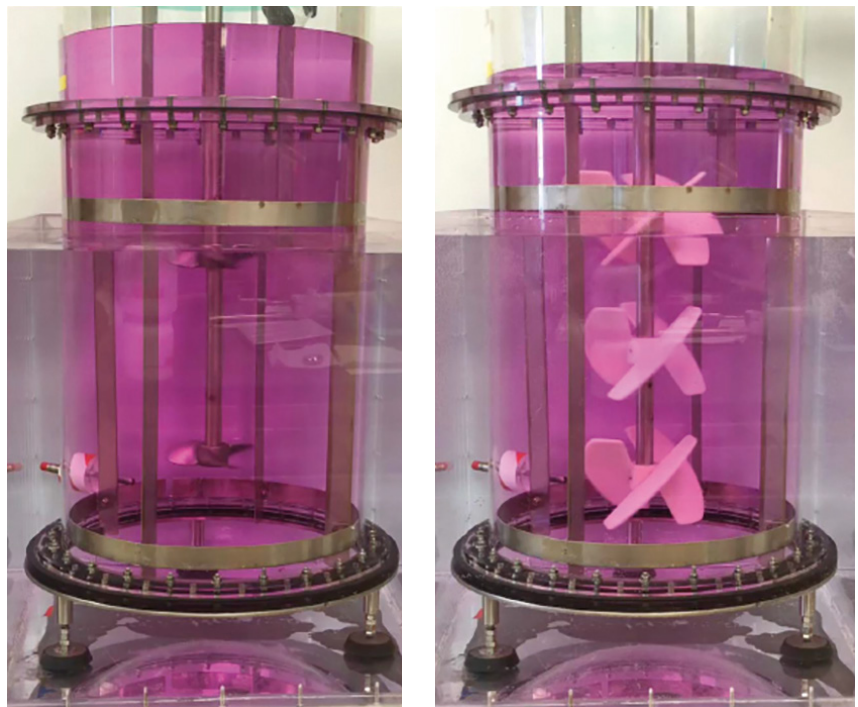

Figure 1: Experimental setups used for small-scale model testing of impeller configurations



Technology challenges in bioreactor modeling

One of the main technology challenges facing ABEC customers is accurately predicting and modifying bioreactor performance across a wide range of scales and platforms. Each customer’s specific needs and challenges determines the range of scales across which the predictions need to be reproduced.

According to Paul Kubera, vice president of process technology at ABEC, “A typical scenario might involve a project that has moved from the laboratory bench at the tens-of-liters scale to process development, which may be operating on a few hundreds-of-liters scale. Another company on the verge of production might need to ramp up by thousands of liters in multiple units.”

Platform incompatibilities present another potential obstacle. A company may be operating at one location with a hardware program that is different than the one in use at a manufacturing location elsewhere. To solve this, ABEC assists the biopharmaceutical customer in bridging different platforms, from small to large, to ensure the same results

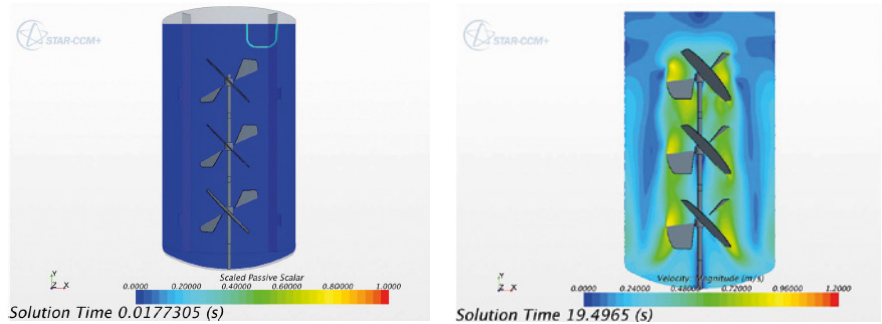

Figure 2: Simcenter STAR-CCM+ simulations of a triple low-shear impeller blender used to simulate the operation of full-scale bioreactor units

are achieved. The challenge is to create a uniform environment that is consistent for each organism in a vessel at each of those scales across platforms.

According to Kubera, “In order to meet the requirements of the project, the growth of the organism must be supported – they need food, a carbon source and to take in oxygen and give off carbon dioxide.”

“It is critical to be able to deliver a known amount of oxygen in a given timeframe, and to be able to remove carbon dioxide for all the organisms in the vessel. Depending on the customer objectives, a

solution is tailored to meet their specific needs based on how tightly they need to constrain that solution regarding processes and validation of those processes.”

“For instance, a customer may be heavily focused on geometric similarity and want uniformity as the equipment operates from a small scale to larger scale. Common practice uses two basic rules: maintain the same power per unit volume and keep everything the same geometrically.”

With this approach, performance parameters change as vessel size



increases – for example, blending times increase, operating speed shifts and mixing forces get larger. All these changing parameters must be accounted for by the customer, who is growing the organisms. With ABEC's use of predictive desktop calculations and simulations, customers have insight into the entire process.

Validating at small scale, executing at large scale

ABEC employs a variety of approaches and methods to create solutions to these problems. These include calculations, lab models, testing of production equipment and computational fluid dynamics (CFD) modeling.

ABEC has found the most effective process includes desktop calculations, small-scale tests to generate data and validate CFD, full-scale CFD modeling and full-scale confirmation testing. ABEC relies on Siemens Digital Industries Software's Simcenter™ STAR-CCM+™ software for conducting CFD.

The desktop exercise tabulates information across the range of scales, including parameters for vessels and agitator details and size along with information on customer operation. Kubera observes, "We will look at consistent power per volume to start and

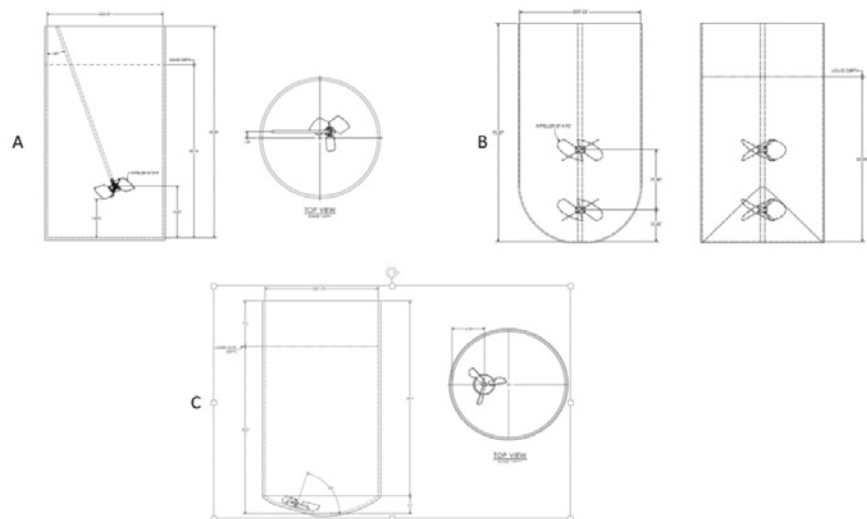

Figure 3: Platform options for bioreactor performance evaluation

see how various parameters like oxygen transfer, or shear rate changes. This comes out of the calculations and simulation."

"With Simcenter STAR-CCM+, we can run a computational simulation of the laboratory configuration and confirm the same results. We can then run a large-scale simulation and be confident that measured performance of the delivered equipment will track with expectations. As an example, we demonstrated that we can cut blend time 50 percent by using laboratory tests to screen options

and Simcenter STAR-CCM+ simulation to extend the results."

Demonstrating success

ABEC's expertise includes understanding process systems and simulation tools to support reactor design. It uses finite element analysis (FEA) for structural simulation, and CFD for fluid flow and process simulation. ABEC's investment in tools for process benchmarking and simulation have yielded a high return, allowing them to reduce their reliance on full-scale experimentation, ensure process stability across sites and

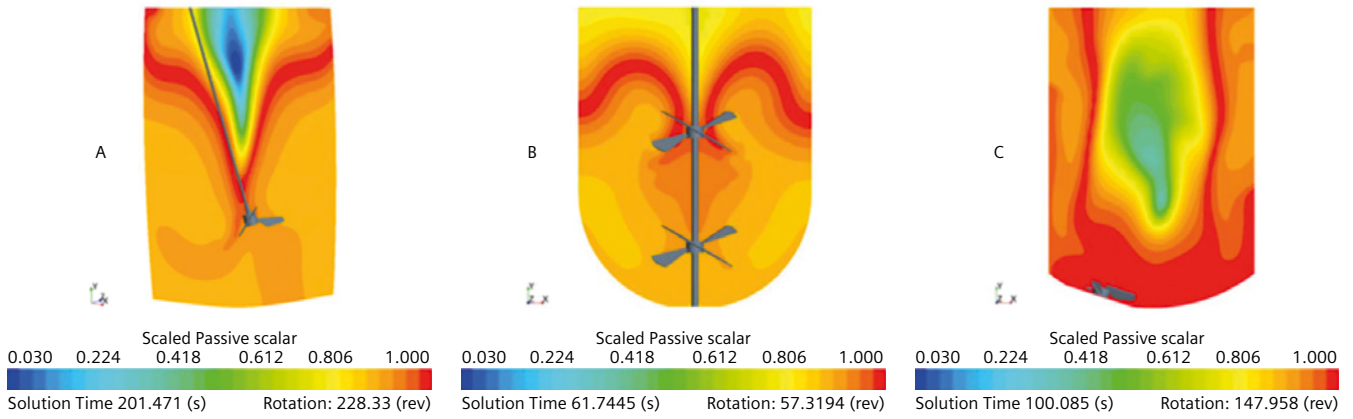

Figure 4: Comparing CFD simulations at full scale (at 95 percent volume uniformity) for each platform option, showing more homogeneous mixing in platform B

platforms, increase the potential for enhanced production yield and reduce time-to-market.

One typical application of CFD in bioreactors is evaluating impeller blade designs for improving the blend time. As illustrated in figures 1 and 2, ABEC’s approach is to validate the Simcenter STAR-CCM+ CFD model using results from small-scale experiments with impeller designs, then using the validated CFD model to extrapolate the results to full scale.

Another typical application involves the evaluation of various bioreactor production platforms for cell culture and bacterial fermentation – a critical first step in the production of biologicals. The goal is to assess the suitability of each platform for providing the same environment for each organism independent of scale. As illustrated in figures 3 and 4, ABEC uses Simcenter STAR-CCM+ simulations to guide the selection and determine which one best suits the customer’s volume, geometry, environmental, production, schedule and economic constraints.

Yet another application involves the detailed assessment of concentration vessel geometries: as product is concentrated in filtration applications, a “stepped volume” configuration (as illustrated in figure 5) is often used to manage batch geometry. When a new product or process suggests the use of a smaller sump volume, the question arises as to whether the sump volume should be modified, rather than replacing the entire tank. Changing to a smaller sump leads to a smaller mixer, which affects blend time, vortex formation, and short-circuiting (referring to the situation where recirculated flow exits the tank quickly and is not well-blended with the sump contents). ABEC uses Simcenter STAR-CCM+ simulations to generate detailed insights into the effects of geometry and mixer options on each of these characteristics. As illustrated in figures 6 and 7, simulations reveal details of the velocity vectors, flow streamlines, particle tracks and even the air-water interface, leading to insights about the level of mixing, vortex formation and air entrainment resulting from any given sump volume and mixer combination.

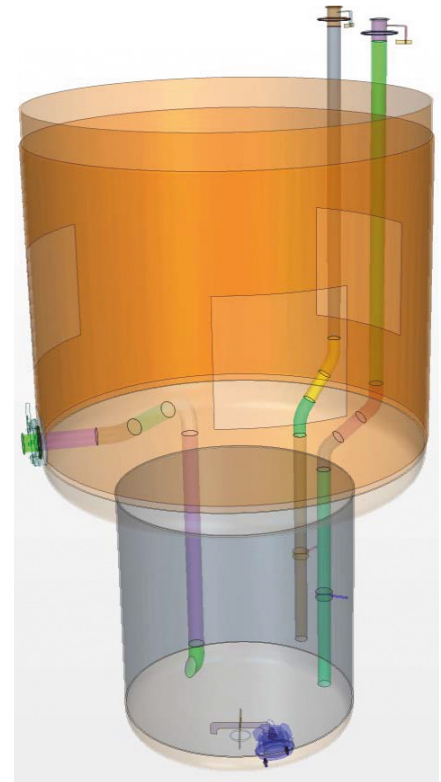

Figure 5: “Stepped volume” configuration used to manage batch geometry as product is concentrated in filtration applications

“As an example, we demonstrated that we can cut blend time 50 percent by using laboratory tests to screen options and Simcenter STAR-CCM+ simulation to extend the results.”

Paul Kubera
 Vice President, Process Technology
 ABEC

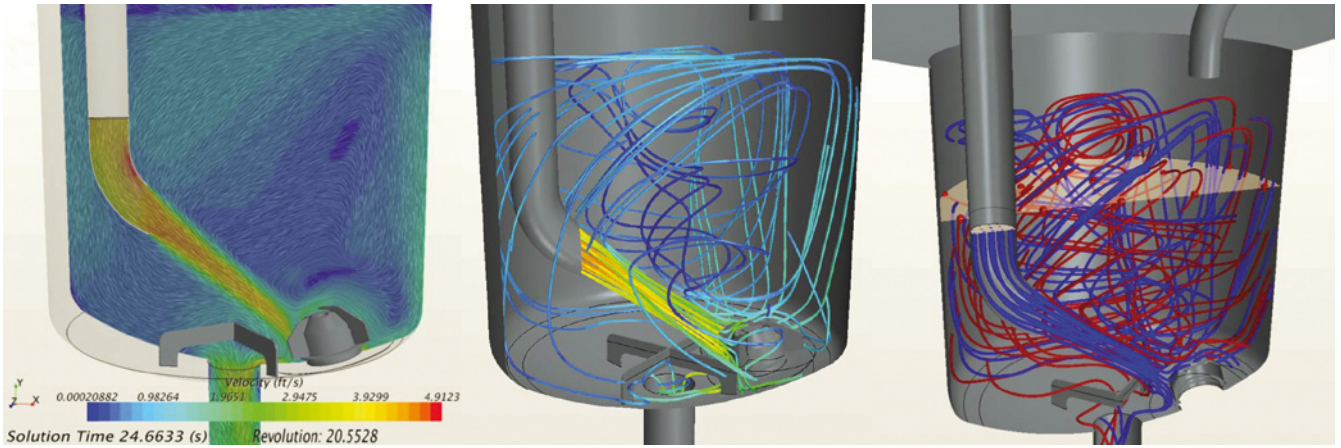

Figure 6: Simcenter STAR-CCM+ simulations showing velocity vectors, flow streamlines and particle tracks in the sump, indicating little short-circuiting and quick dissipation of the recirculating flow by the impeller

In each of these cases, robust, high-fidelity CFD simulation refines understanding, addresses questions and verifies expected behavior at scale, which is especially critical in situations where experimentation is not practical.

effectively doubling the industry standard capacity for single-use bioreactors. ■

As valuable a tool as Simcenter STAR-CCM+ is for ABEC, they are aware that it is capable of even more: “We don’t perform enough CFD to take full advantage of all that it can do for us,” says Kubera. “Siemens provides us with the support we need to demonstrate to our customers this equipment can operate in a very predictable fashion immediately upon startup, reducing their time-to-market. Our relationship with Siemens Digital Industries Software helps us very capably provide that service.”

“With Simcenter STAR-CCM+, we can run a computational simulation of the laboratory configuration and confirm the same results.”

ABEC continues its innovative path, recently introducing the 4,000-liter Custom Single Run™ bioreactor,

Paul Kubera
Vice President, Process Technology
ABEC



Figure 7. The air-water interface in the sump, showing a low level of deformation, indicating no vortex formation or air entrainment

Brabant Engineering

Siemens Digital Industries Software helps to design an innovative marine stabilizer system

Siemens Digital Industry Solutions help marine manufacturer reduce product development costs and prototyping test cycles

Stability at sea

If there's anything that can spoil a relaxing trip on the water, it's an unstable boat. Choppy surf can cause significant damage to personal belongings as well as the boat. Whether you're fishing, scuba diving or just out on the water, ship stability is an essential part of safe sea travel. As a result, ship stabilizers are valuable commodities.

Any experienced sailor understands the importance of marine stability in ensuring a sound trip at sea; however, not every stabilizer system is perfect. In fact, a common issue with conventional fin-driven stabilizers is insufficient roll dampening at lower speeds and their protruding fins. This issue has hampered the consumer experience. Stability is necessary at low speeds, and protruding fins can become damaged in shallow waters. The last thing your customer wants is to be out at sea when their new stabilizer fails. Considering consumers have a low tolerance for product failure, one bad experience may be all it takes for consumers to jump ship from your product. Only the stabilizer manufacturers who deliver consistent quality survive.

Realizing opportunity

Located in 's-Hertogenbosch, Netherlands, DMS Holland is an international specialist in the field of motion control on yachts of up to 30 meters. DMS Holland's goal is to reduce the roll movement of yachts to improve onboard comfort, reduce sea sickness and improve safety. The speed in which DMS Holland's marine stabilizer systems achieve stabilization differentiate themselves in the market. Their stabilizer systems are based on the Magnus effect, a phenomenon in which a rotating cylinder works away from its principal paths of motion to achieve stability.



“I have been using Simcenter 3D for the last seven years and I am very fond of the versatility of the software. This versatility allows companies to predict the behavior of different aspects of a product’s design to find the most effective solution.”

Bertie Tilmans
Lead Engineer
Brabant Engineering

Where a traditional stabilizer requires a yacht to be traveling at a considerable speed, their product achieves stabilization at just 3 to 12 knots. This differs from conventional fin-based systems due to its small design and greater roll dampening abilities at lower speeds. Furthermore, the Magnus Master features retractable rotors, eliminating the risk of damage.

“DMS Holland wanted to provide the highest level of stability, comfort, and safety onboard. Overall, we wanted to make life at sea much more comfortable and easy,” says Patrick Noor, sales and marketing director, DMS Holland. “To realize our vision, we need quality companies such as Brabant Engineering to assist us with the mechanical engineering for our stabilizers.”

Brabant Engineering, a mechanical engineering company in Best, Netherlands, is responsible for the design and development of DMS Holland’s Magnus Master, the newest generation of rotor stabilizing technology. The company is providing DMS Holland with their design expertise to develop the forward-thinking product they envisioned.

Sailing toward solutions

Brabant Engineering utilizes the innovative design applications found in Siemens Simcenter™ 3D software to accurately design and simulate its projects.

“All the material properties are embedded into the software design, and Simcenter 3D helps us analyze the behavior and durability of our product,” says Bertie Tilmans, lead engineer, Brabant Engineering. “By providing accurate material properties and seamless integration of multiple design alternatives, we can save valuable time during product development.”

Brabant’s engineers used Simcenter 3D to accurately simulate the Magnus effect and confirm the Magnus Master could handle 1,100 revolutions per minute.

“I have been using Simcenter 3D for the last seven years and I am very fond of the versatility of the software,” says Tilmans. “This versatility allows companies to predict the behavior of



different aspects of a product's design to find the most effective solution."

Reducing development costs and prototyping cycles

By properly utilizing computer-aided design (CAD) software – such as with Brabant's use of Siemens NX™ software – Brabant Engineering uses the powerful and flexible capabilities of NX CAD to drastically reduce the cost and time it takes to design such innovative products. The combination of NX CAD for design and Simcenter 3D for performance prediction help to accelerate product to market efficiently. Rikkert Gerits, project leader at Brabant Engineering, confirmed that using Simcenter 3D dramatically reduced the amount of physical prototyping necessary.

"Using 3D simulation tools, we don't have to build an actual prototype, which saves us considerable time and money," says Gerits.

CAD systems offer users the ability to easily interchange various product components. CAD and computer-aided engineering (CAE) systems also provide

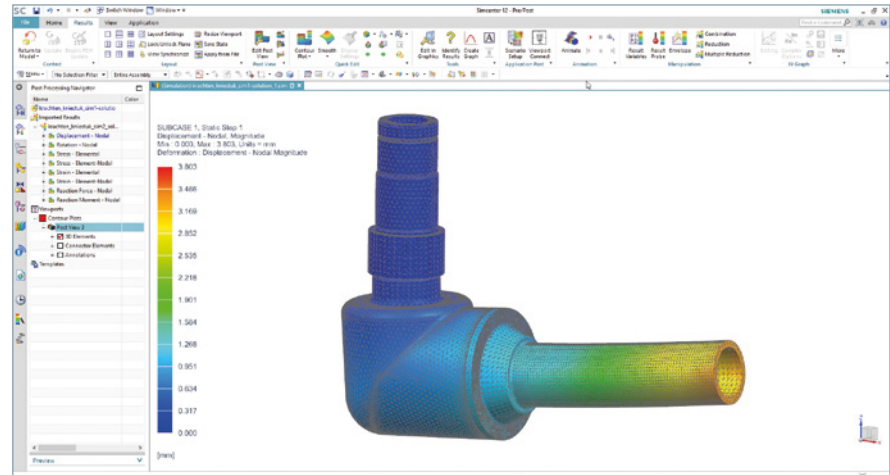

the necessary tools to rapidly re-engineer and explore the performance of new designs. Rikkert explained how these simulation systems also allow for a speedy virtual-prototyping phase. By simulating the product in real time, users can more accurately predict product durability under certain conditions. This provides companies with significant cost and time savings when compared with designing, producing, testing and recording data of a physical prototype.



“Using 3D simulation tools, we don’t have to build an actual prototype, which saves us considerable time and money.”

Rikkert Gerits
Project Leader
Brabant Engineering

Rikkert adds, “We use several Siemens products, like Simcenter, NX CAD, and Teamcenter, and they’re delivered by cards PLM Solutions, a Siemens Digital Industries Software solution partner. We can contact them with any specific question we have regarding the software.”

Establishing a strong relationship

Sjef van de Laak, managing director, Brabant Engineering, says Siemens solutions are key in the company’s engineering design process. “Siemens is the supplier of the software we use, and the importance of cards PLM Solutions is they know the software very well and support our simulation needs,” he says.”

Product development would be disrupted without this open line of communication. As such, cards PLM Solutions and Brabant Engineering maintain a constant dialogue.

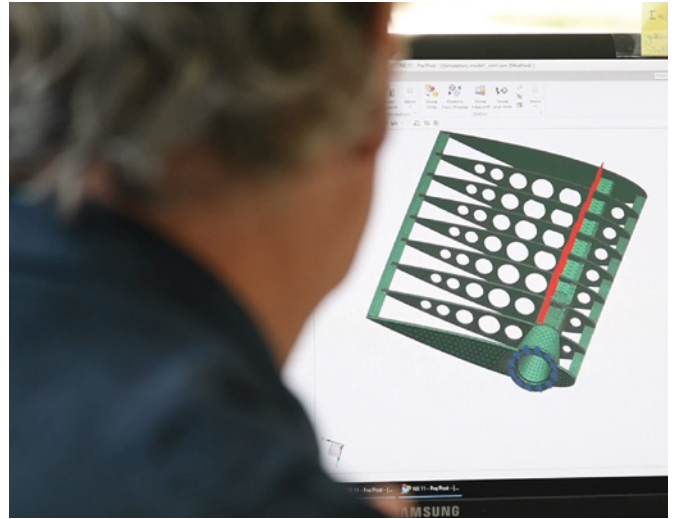
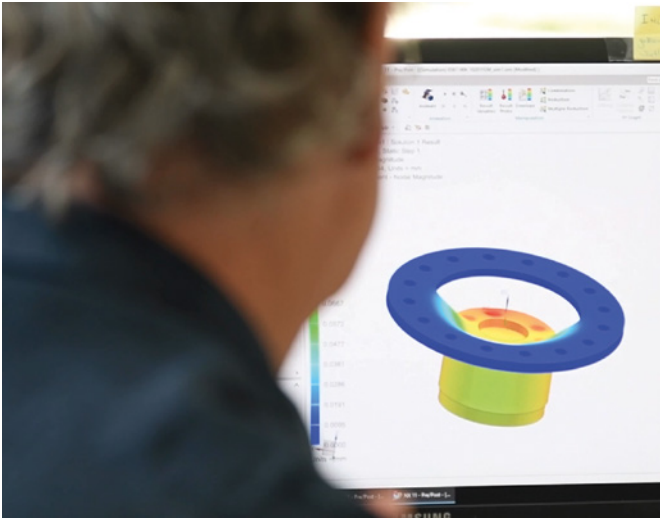

Sharing the Magnus Master worldwide

The Magnus Master is already receiving considerable attention. Since its introduction in 2015, the Magnus Master has developed a reputation of quality throughout the Netherlands and helped make DMS Holland a global business.

With the Magnus Master being designed and tested, DMS Holland can begin mass-marketing their new product. This combined effort between Brabant Engineering, DMS Holland, and Siemens is a perfect example of how cooperation can lead to groundbreaking innovation. ■

“Siemens is the supplier of the software we use, and the importance of cards PLM Solutions is they know the software very well and support our simulation needs.”

Sjef van de Laak
 Managing Director
 Brabant Engineering

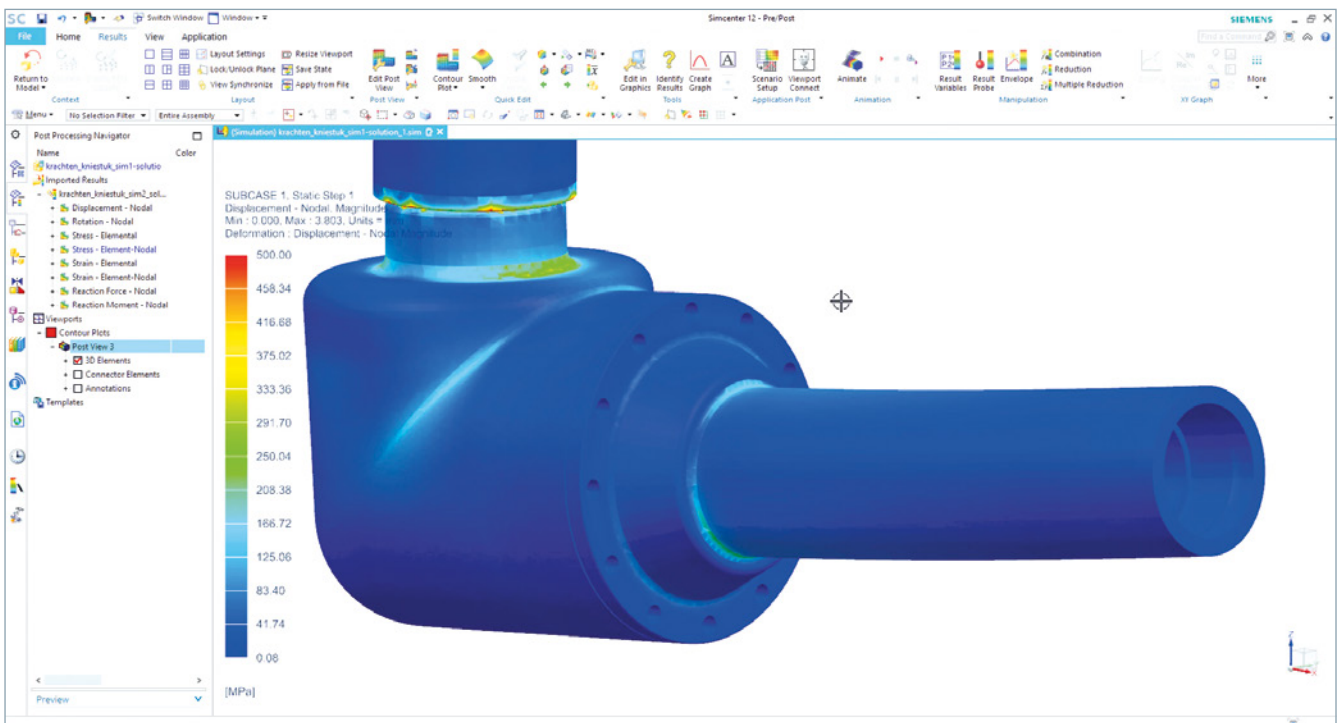

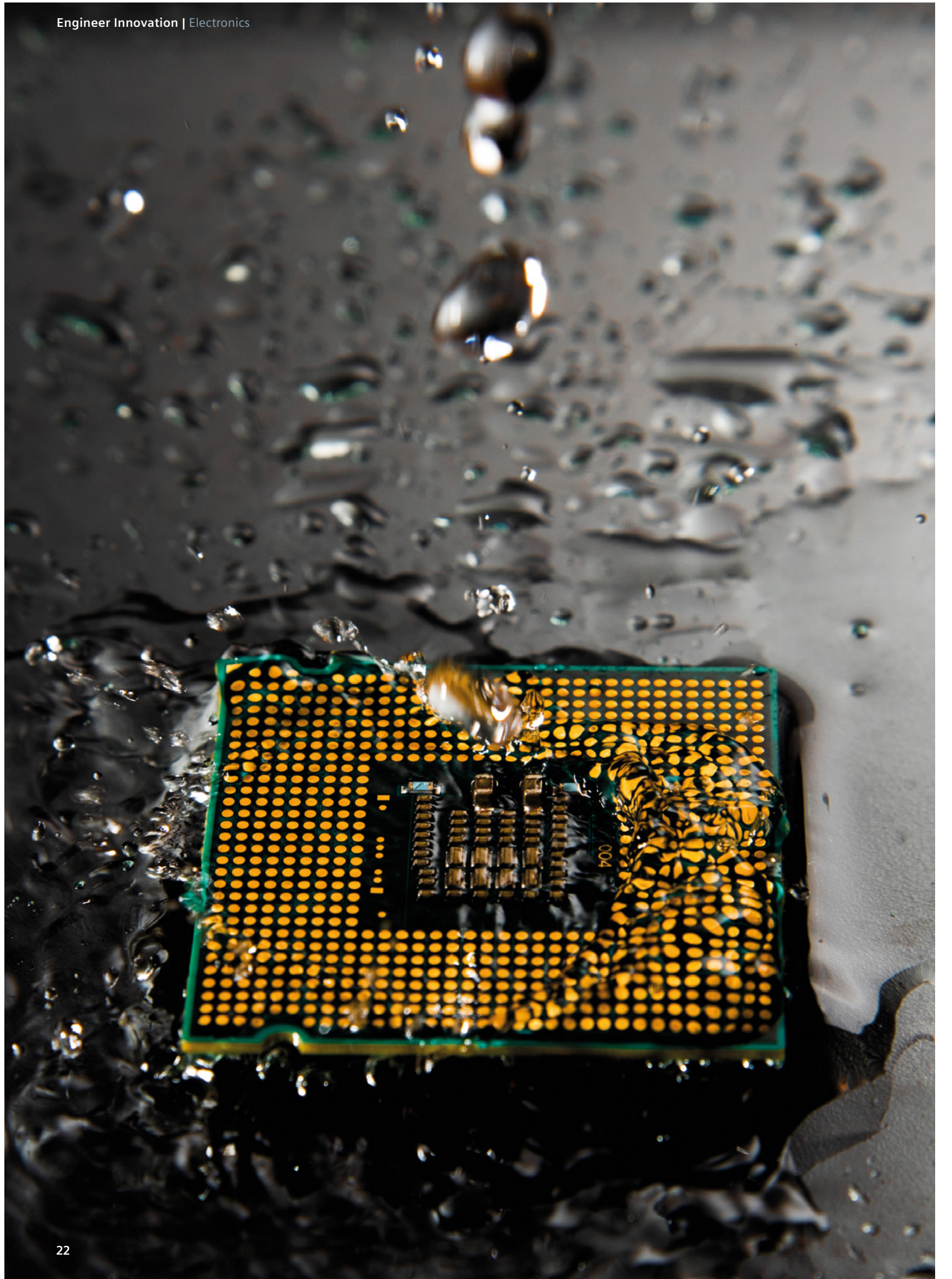

Interview

Deep learning with Guy Wagner



Guy Wagner (GW): My name is Guy Wagner and I am a director at Electronic Cooling Solutions in Santa Clara, California.

GW: After finishing graduate school, I hired with Bell Laboratories where I worked as a member of technical staff for nine years. After leaving Bell Laboratories, I hired on with Hewlett-Packard and did mostly cooling technology at Hewlett-Packard for their workstations. I developed a new cooling technology called the ArctiCooler, which was to be commercialized, and we formed a business unit called Polar Logic, which was to produce the ArctiCoolers.

After leaving Hewlett-Packard, I was with two start-ups. And in 2010, I joined Electronic Cooling Solutions as a director of the company.

Engineer Innovation: What are you working on at the moment?

GW: One of the most interesting projects I've been working on is the cooling of a deep learning machine that uses neural networks. The neural networks are on 84 integrated circuits (IC) on a board that is 20 centimeters on a side. This module dissipates 17,600 watts of power and requires liquid cooling since air cooling cannot handle this type of power density.

EI: How did you use Simcenter™ Flotherm™ XT software in this project?

GW: Simcenter Flotherm XT was used to simulate this module with all the ICs in place. The ICs are pressed against a cold plate that has micro channels on the back, and we used 30 percent propylene glycol/water coolant that flows through these micro channels at 20 gallons (76 liters) per minute. The coolant is pumped through the micro channels in parallel channels so that each IC gets the same amount of coolant flow at the same temperature. By using Simcenter Flotherm XT we were able to model all the micro channels and all the passages within the module and optimize the fluid flow through the module so that each IC got exactly the same amount of coolant, and as a consequence each IC runs at almost the same temperature, which was one of the requirements for this machine to work properly.

EI: How did it benefit you as an engineer to use Simcenter Flotherm XT for this project?

GW: Simcenter Flotherm XT allowed us to model this learning module with the thousands of micro channels in the cold plate in detail. By using Simcenter Flotherm XT with SmartCell technology we were able to model the fluid flow through each micro channel without having to make simplifications to the model. We used Simcenter Flotherm XT to optimize the spacing and dimensions of the channels within the unit to give us a fluid flow to each IC that was identical

to all its neighboring ICs. This kept the temperature of all of the ICs within a very narrow range, which was necessary for the proper operation of this learning machine.

EI: How do you see Simcenter Flotherm XT being used in the future at ECS?

GW: Simcenter Flotherm XT has given ECS the capability to model our client's products in detail. We find that we are using it more and more for each job that we get because it does two things for us. It allows us to model the exact computer-aided design (CAD) as the customer would like to see it, and it has capabilities that exceed the previous generations of computational fluid dynamics (CFD) software.

EI: Okay. Final question. In the time that you have been an engineer, what are the biggest changes you have seen?

GW: In the time I've been involved in engineering, the software has improved to the point where the output of the simulation software looks just like the CAD that was sent to us. The clients are very happy to see that we are modeling their product in exact detail. The second major change is that the computing power of the desktop has evolved and improved to the point where we can now do simulations on the desktop that would have required a super computer ten years ago.

Validation of Packaging Thermal Resistance

Brian Philofsky, Principal Technical Marketing Engineer, Xilinx, Inc.

Introduction

Perhaps the most useful metric for a thermal engineer when it comes to a flip-chip BGA (Ball Grid Array) is the junction-to-case thermal resistance (R_{JC}). A lower R_{JC} has direct implications on the thermal design required to maintain the temperature of the device, along with the heat dissipation and surrounding environment. A package with a lower junction-to-case thermal resistance has better thermal performance. junction-to-case thermal resistance is one of the metrics that Xilinx publishes in datasheets, as shown Table 1, to allow designers to compare thermal performance of devices. While a low R_{JC} is desired, it is equally important that the measurement result be reproducible on the same device and reliably yield the same value when measuring a sample of parts.

Historically junction-to-case thermal measurements involved using a thermocouple mounted on the case surface to determine the case temperature. For a variety of reasons the use of a thermocouple hasn't provided the adequate repeatability necessary when measuring junction-to-case thermal resistance. Getting

this measurement wrong can lead to over-design and higher costs associated with the thermal solutions. In order to provide consistently repeatable measurement data Xilinx bases the R_{JC} measurement on the JEDEC JESD51-14 standard [1]. This method uses the difference in transient thermal response for two thermal interfaces between the case and cold plate surfaces to identify the thermal resistance between the junction and case.

Recently a customer requested characterization data of the XCZU15EG-FFVB1156 device to validate the published JEDEC R_{JC} value of 0.19 K/W. To facilitate this request Xilinx contracted Mentor, A Siemens Business to perform an external validation of the packaging thermal resistance. Four devices from three sources (Customer Production, Customer Engineering Sample, and Xilinx Production) were provided for the measurement. One of the devices mounted on a JEDEC 2S2P PCB is shown in Figure 1.

Measurement Setup

Each measurement consists of placing the device under test, which consists

of the BGA mounted on a JEDEC 2S2P PCB, in the fixture (shown in Figure 2). Thermal grease is applied between the package case and the cold plate and a clamping force is applied. The BGA package is electrically connected to the Simcenter™ T3STER™ measurement hardware. A heating current is applied through the electrical connection until steady state is reached. At this point the heating current is reduced to a very low sensing current and the data collection phase of the measurement begins. The measurement ends when the lower temperature steady state condition is reached. The measurement is repeated with a different amount of thermal grease between the device and cold plate.

The measurement results are processed in the Simcenter T3STER Master software to produce Structure Functions. The Structure Function represents the Thermal Capacitance vs. Thermal Resistance along the heat transfer path from the device junction to the cold plate. The structures derived from each of the two tests will be identical up to the point they separate due to differing amounts of thermal grease at the case surface. JEDEC JESD51-14 provides a consistent



Figure 1: Xilinx Package mounted on JEDEC 2S2P PCB

Package	Package Body Size	Devices	Θ_{JB} (°C/W)	Θ_{JC} (°C/W)	Θ_{JC} (°C/W)	$\Theta_{JA-Effective}$ (°C/W)		
						@250 LFM	@500 LFM	@750 LFM
FFVB1156	35 x35	XCZU6	1.95	0.17	7.8	5.1	4.2	4.0
		XCZU9	1.95	0.17	7.8	5.1	4.2	4.0
		XCZU15	1.82	0.19	7.7	5.0	4.2	4.0

Table 1: Thermal Resistance Data



methodology to determine the point of separation between the two measurements. The point of separation identifies the junction-to-case thermal resistance.

Measurement Results

The results of each measurement is represented with Cumulative Structure Functions as shown in Figure 3. The values of R_{jC} ranged from 0.14 K/W to 0.19 K/W.

Conclusion

The independent measurement results, provided by Mentor, A Siemens Business, on all four samples were at or below the Xilinx user guide value of 0.19 K/W for the Xilinx XCZU15EG-FFVB1156 device. The results are encouraging as it indicates that Xilinx is providing the most accurate design data available to their customers. Having quality published data allows customers to make informed choices and also develop the appropriate thermal design in the least amount of time.

References

- [1] "JEDEC JESD51-14," Standard Transient Dual Interface Test Method for the Measurement of the Thermal Resistance junction-to-case of Semiconductor Devices with Heat Flow Through a Single Path, 2010. ■

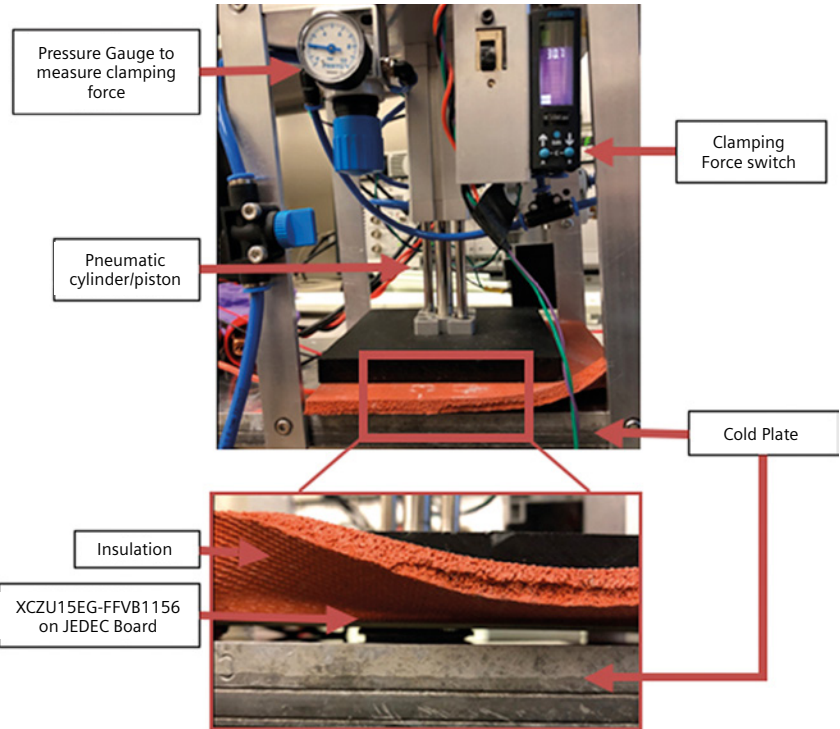

Figure 2: Measurement Fixture

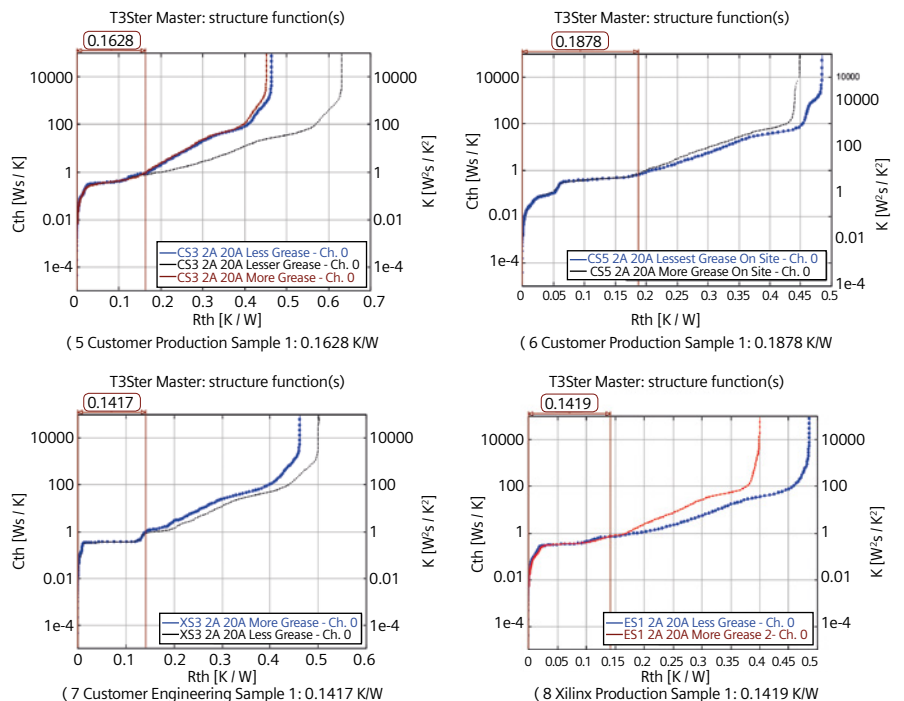

Figure 3: R_{jC} Measurement Results



Nissan Technical Centre Europe

Implementing end-to-end Simcenter solutions for test-based durability engineering



Nissan uses Simcenter SCADAS and Simcenter Testlab to implement state-of-the-art durability engineering processes

Tuning vehicles to local custom needs

In 2017, Nissan enjoyed a record year with 5,820,000 cars sold globally. That year, Renault-Nissan Alliance became the world's leading seller of passenger vehicles, surpassing Volkswagen.

Nissan's brand awareness and recognition is at its zenith. In fact, YouGov BrandIndex, which measures the public perception of thousands of brands in Europe, reports that Nissan is the fifth-ranked automobile supplier (of 38) consumers in the United Kingdom.

To continue increasing brand perception, as well as improving the quality ranking, Nissan sets high standards in regard to engineering quality and reliability, it is essential to understand and address the needs and requirements of its local customers.

The role of the Nissan Technical Centre in Europe (NTCE) is to support Nissan's reputation and ensure that performance attributes of new vehicle designs and concepts meet European consumer expectations. Nissan Technical Centre Spain (NTCE-S) is a center of excellence for the design and development of vehicles manufactured across Nissan's European production plants, focusing on key activities such as powertrain development, light commercial vehicle engineering and testing.

Nissan is committed to offering its European customers the highest standards of quality and reliability. This is one of the reasons why NTCE-S invested in Simcenter software solutions from Siemens Digital Industries Software for test-based durability engineering to bring its engineering capabilities to the next level.

Durability is key

The main role of the function and durability department at NTCE-S is to validate the functional performance of

an engine's components over the vehicle's lifecycle. To assess performance, the team conducts extensive tests on components fitted on NTCE's engine dynamometer (dyno). It also evaluates the component's performance in a full assembly configuration, where the complete vehicle is positioned on the chassis dyno. Finally, the team puts passenger cars and light commercial vehicles (for example, pick-up segment) through fatigue tests, either on the test bench or the test track.

A large number of the tests performed by the function and durability team are durability tests. Durability is an important performance attribute of passenger and light commercial vehicles. In the light commercial vehicles market segment, consumers are inclined to select a brand they trust will support their daily needs.

"Durability is extremely important," says Arturo Barreu, powertrain durability test engineer, function and durability department, NTCE-S. "In Europe, this attribute is closely associated with the perception of quality. As the demand for quality increases, we need to confirm the durability of our vehicles. Consumers expect vehicles will not break down after only one year, but up to 20 years."

Other attributes such as ride and in-vehicle comfort, engine power and fuel efficiency are also important in the vehicle's design. The role of a durability engineer has become more complex as durability engineering teams need to take more parameters into account when conceiving and testing components, subsystems and full systems of next-generation vehicles.

Streamlining processes

One of the steps the team took to improve durability engineering was to invest in solutions from the Simcenter portfolio. With its portfolio, Siemens Digital Industries Software helps streamline the engineering process by offering an end-to-end solution for test-based durability engineering.

A complete durability test campaign encompasses measurements on the engine dyno, followed by



“Simcenter Testlab is our preferred tool for durability validation. It is easy to configure and allows us to automate processing.”

Arturo Barreu
Powertrain Durability Test Engineer
Function and Durability Department
NTCE-S



“We test more and more electronic components and less mechanical parts. The collaboration with Siemens is essential to adapt to these changes and to validate these new components.”

Arturo Barreu
Powertrain Durability Test Engineer, Function and Durability Department
NTCE-S

measurements on the chassis dyno, after which the test team moves to the test track. As the engineers are required to move the test equipment from one location to the next and to instrument the test item anew, they appreciate the portability and flexibility of Simcenter™ SCADAS hardware.

“We use Simcenter SCADAS™ hardware for all our data acquisition tasks,” says Barreu. “It is a portable system which is very compact. It is also versatile, adjusting to our needs. With it, we can acquire different types of data such as acceleration or strain, using the same equipment. Our Simcenter SCADAS data acquisition systems total more than 100 channels, which we can easily transport from the engine dyno to the chassis dyno and to the test track and back.”

Beyond data acquisition, the team streamlined its durability engineering process by relying on Simcenter Testlab™ software for load and fatigue analysis. The software effectively supports every step of a testing campaign, from data acquisition to load classification and fatigue life prediction. Moreover, it forms part of a platform dedicated to multiphysics test-based performance engineering and, as such, better helps balance the contribution of various performance attributes such as acoustic, comfort and durability, combined with low weight and fuel economy, to the overall perceived quality and reliability.

The function and durability department’s main responsibility is to test and validate the functional performance of engine-related components. The engineers, meanwhile, acquire, analyze and compare test data on a large number of components and engine subsystems. They combine the outcome of durability analyses, such as time at level, rain flow counting, range pair counting, level crossing, and fatigue life prediction, with typical noise, vibration, and harshness (NVH) analysis results, which can include peak hold spectra, order sections, colormaps, and many more. All durability and NVH data is acquired using the same Simcenter SCADAS hardware, and the analysis is performed in a single software environment, making it a very efficient process for the engineering team.

“The key challenge that we are confronted with is the consolidation of our knowledge,” says Barreu. “We have to test more components now than ever before. These components are also of a different nature. We test more and more electronic components and less mechanical parts. The collaboration with Siemens is essential to adapt to these changes and to validate these new components.”

For the validation of the component on the test rig, the team uses Simcenter Testlab to synthesize an equivalent damage profile and to consequently emulate the damaging events encountered during test track measurements on the rig. This highly efficient process significantly



accelerates testing by realistically simulating the damage experienced by the component during the operational life of the vehicle.

NTCE engineers have found that Simcenter Testlab offers great stability, independent of channel count, making it easy for them to configure online analyses. The solution also provides fast and error-free data postprocessing thanks to the Process Designer functionality and offers immediate, clear reporting.

“Simcenter Testlab is our preferred tool for durability validation,” says Barreu. “It is easy to configure and allows us to automate processing. It is also a very good software for quick reporting and data sharing with our colleagues.”

The outcome of the tests produce reliable data that can be endlessly manipulated to deliver deep engineering insight into the fatigue behavior of the components. This data supports the definition of further tests or feeds the simulation models with trustworthy validated information.

“Simcenter Testlab offers an integrated end-to-end solution for load data acquisition and processing,” says Guillermo Gonzalez, function and durability senior engineer, NTCE. “The solution accelerates the delivery of critical durability insights when preparing for test rig campaigns or reliable simulations. It is faster, easier to use and robust.” ■

“Simcenter Testlab offers an integrated end-to-end solution for load data acquisition and processing.”

Guillermo Gonzalez
Function and Durability Senior Engineer
NTCE fatigue



Ural Locomotives

Train manufacturer uses NX, Teamcenter and Simcenter to reduce time-to-manufacture by 40 percent



Siemens Digital Industries Software solutions help Ural Locomotives launch Russia's first modern high-speed electric train in less than three years

Birth of the swallow

High-speed trains shorten the travel time between the regions of a large country such as Russia, and offer excellent riding comfort. The first such train assembled in Russia was the Lastochka (the EC2G make). It can go 160 kilometers per hour (km/h), and the standard five-carriage train can carry up to 1,500 passengers. The Lastochka, which means "swallow bird" in Russian, has been modified to better match the country's conditions: The electric train can run in a tropical climate and in a frigid northern climate. The acceptable temperature range is from -40 to +40 Celsius. The carriage door arrangements are suitable for Russian railway platforms that can be installed at various heights.

The Lastochka development began in 2009 when Russian Railways ordered a regional dual-mode electric train from Siemens. The train had to be adapted to

Russian conditions. The new trains were intended for Sochi commuter service during the 2014 Winter Olympics. Then they would serve other routes to provide direct links on tracks with both DC and AC power.

The new Russian train design was based on the Siemens Desiro ML five-carriage electric train. The first 54 EC1 series trains were manufactured by Siemens in Krefeld Germany between 2011 and 2014.

To enable domestic production of the high-speed trains in Russia, in 2010 Siemens AG and Sinara Group established a joint venture called Ural Locomotives, LLC. Today the company manufactures DC (model 2EC6) and AC (model 2EC7) electric freight locomotives and DC mainline electric locomotives (model 2EC10).

"Ural Locomotives was under significant time pressure to not just assemble the electric train in Russia following the original German drawings, but to develop a complete design package that complied with Russian standards for the

product assembly with components from Russian suppliers,” says Vitaly Brexon, deputy chief executive officer (DCEO) for engineering policy, Ural Locomotives. “The local content had to be really high, so we needed the original 3D models.”

A track to digitalization

After an in-depth analysis, Ural Locomotives decided to deploy Siemens Digital Industries Software solutions to produce the Lastochka for several reasons: First, it would facilitate the use of a high level of local content; second, Siemens’ software is compliant with the Russian unified system for design documentation (ESKD) engineering standards; third, Siemens Digital Industries Software has a highly capable product lifecycle management (PLM) deployment team in Russia, and fourth, Ural Locomotives determined that Siemens’ products offer the most advanced digitalization solutions. This includes systems-driven product development, cost and value engineering, digital engineering analysis and product requirements validation technologies.

A well-coordinated Siemens Digital Industries Software technology deployment led to rapid end-to-end digitalization. It took less than three years to launch an industrial grade production of the Lastochka trains. The local content of the product is as high as 80 percent.

“Siemens Digital Industries Software’s technologies help us to rapidly develop modern rolling stock, and enables us to

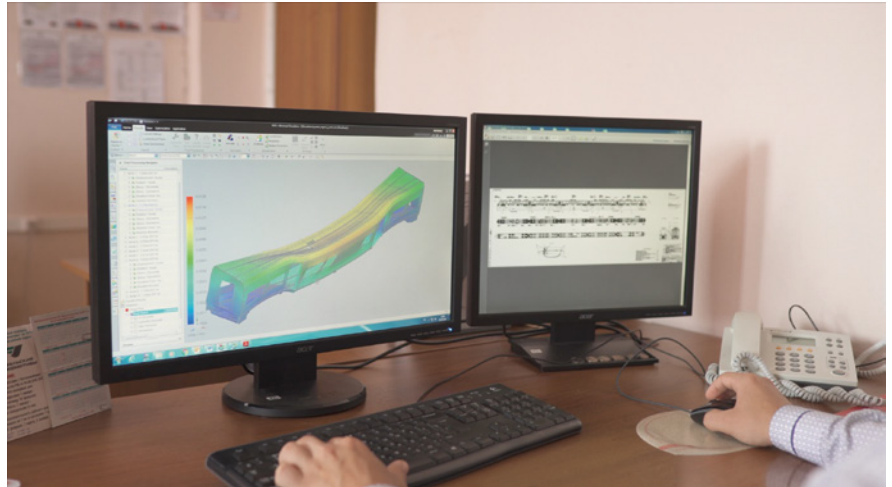

be up-to-date so we can compete with famous companies both domestically and internationally,” says Peter Vaulin, head of the mechanical design division in the research and development (R&D) department of Ural Locomotives.

The digitalization began with the deployment of Teamcenter® software for product data management (PDM) and NX™ software for computer-aided design (CAD). Concurrently the designers received CAD training to enable them to design the Lastochka train based on the DESIRO RUS platform.

Ural Locomotives took a comprehensive approach to information technology (IT) deployment as the board of directors decided to establish a corporate-level integrated information system. The corporate enterprise resource planning (ERP) management system and Teamcenter integration project included transferring digital product structures

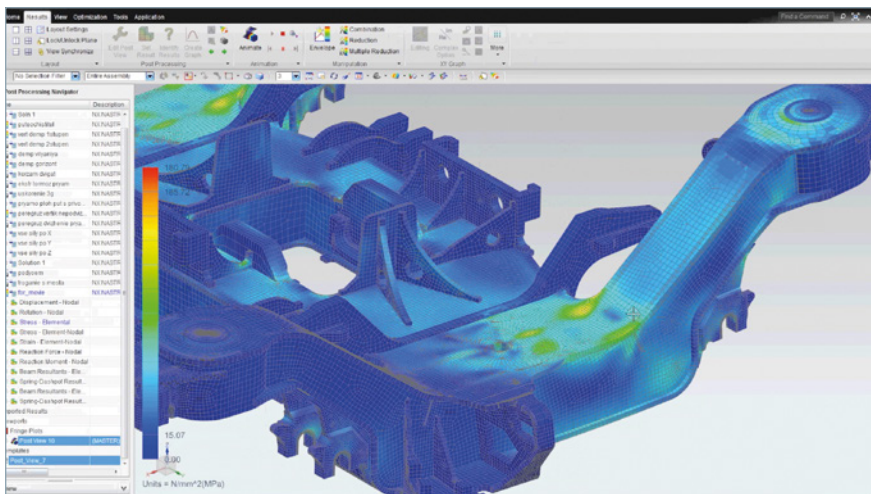



“Siemens PLM Software’s technologies help us to rapidly develop modern rolling stock, and enables us to be up-to-date so we can compete with famous companies both domestically and internationally.”

Peter Vaulin
Head of Mechanical Design Division, R&D Department
Ural Locomotives

and changes. The integration has been implemented with built-in Teamcenter tools. It has enabled Ural Locomotives to establish a unified information environment for all of its divisions. It has also improved the performance and coordination of the manufacturing and auxiliary departments.

Introducing Siemens PLM Software into the design process has resulted in a unified approach to managing design documents, product structure, references and document storage. Now the design documents are reviewed and approved digitally across the

departments. The designers develop 3D models while 2D drawings and bill-of-materials (BOMs) are generated automatically. They handle large assemblies, perform engineering analysis and computer numerical control (CNC) code generation using 3D part models.

Using concurrent engineering in NX that is managed in Teamcenter has helped the firm design the complicated components of the Lastochka electric train and its modifications in an efficient and high-quality way, removing errors in design documents and establishing an automated compliance check procedure.

“Working with Teamcenter, the designers concurrently develop all the components in a single model and can see any updates made by other stakeholder,” says Dmitry Khaziyev, senior design engineer, locomotive underframe department, mechanical design division. “Such an approach reduces errors that are hard to identify with other design procedures and would likely only be found once the product was assembled.”

Delivering accurate analysis

Due to the close partnership with Siemens PLM Software’s Russian team, company experts have quickly mastered structural element strength, rigidity analysis and dynamic train performance analysis to estimate ride smoothness and the comfort of passengers. To meet the passive safety and crash worthiness requirements, collisions with obstacles



on the track have been virtually simulated.

Siemens PLM Software’s Simcenter™ software is an engineering analysis tool that has enabled Ural Locomotives to create an efficient Lastochka train and locomotive design in a virtual environment without many physical tests.

“Engineering analysis systems like Simcenter significantly boost the performance of our engineers, analysts and designers, and reduce the scope of works for the test engineers,” says Peter Vaulin, head of the mechanical design division, research and development (R&D) department of Ural Locomotives. “In the shortest time possible we try a large number of design options and evaluate each design virtually without building any prototypes. It saves a lot of time. Now we can develop modern rolling stock really fast, and be

up-to-date. We compete with famous companies both domestically and internationally.”

With the digitalization approach used in the Siemens PLM Software’s solutions today, Ural Locomotives fully complies with all the custom union standards, certification requirements and directives.

Achieving safety and comfort

The Lastochka train design meets all the safety and ergonomics standards. The train body components are made of extruded aluminum. The metal is corrosion-resistant, while the special panel design ensures low weight and structural rigidity of the carriage required for a high-speed ride. The manufacturing of such body parts is quite innovative for Russian industry. It is similar to the aerospace industry, but Ural Locomotives is the only Russian company that manufactures highly complicated parts from long extruded profiles.



“Engineering analysis systems like Simcenter significantly boost the performance of our engineers, analysts and designers, and reduce the scope of works for the test engineers.”

Peter Vaulin
Head of Mechanical Design Division, R&D Department
Ural Locomotives

The CNC machining of carriage body parts had to be planned from scratch. The initial task was to machine a carriage size panel 23.9 meters (m) long. The wall components misaligned by two to three millimeters (mm) when fixed to the machine tool. Even worse, the side component length varied by three to four mm. The panel carries important interior components, electric equipment and heating systems. For this reason, it was important and difficult to align all the parts while preserving the panel flatness. The

Siemens PLM Software experts and their colleagues from Ural Locomotives had to adapt the milling operation and correct the CNC code for each panel segment.

The panel was measured and the cloud point was processed with NX CAM. Then the module generated a CNC code perfectly adaptable for any surface irregularities. The adaptive machining technology available in NX CAM takes into account any manufacturing environment changes occurring after the initial analysis.

“Without adaptive milling with NX CAM, it would have been impossible to machine the extruded aluminum parts,” says Vladimir Dudorov, manufacturing engineer, welding and assembly department, Train Production Planning Division, Ural Locomotives. “We would have faced consistent overcuts and faulty parts.”

Having achieved excellent results with the carriage side wall machining, the experts adapted the carriage roof and underframe machining in which the components also have varying length and other special features.

Initially at Krefeld where the Desiro trains were manufactured, such parts were machined using expensive tooling. Now Ural Locomotives is able to use affordable tooling and the workpiece location procedure developed with NX CAM. A train part workpiece is installed on a machine that doesn't require a high degree of accuracy for its extrusion. NX CAM is used to generate the CNC code and a CNC machine performs all the machining. NX CAM generates the CNC code.

The Siemens PLM Software suite of solutions has delivered high-quality manufacturing of the expensive Lastochka train components with lower production planning costs. Manufacturing defects have been eliminated. The solutions based in NX CAM have reduced machine setup time with automated workpiece location, while virtual CNC code simulation has accelerated the planning time by 30 percent. The manufacturing time for carriage workpieces was reduced by 40 percent.



Lessons learned during the Lastochka project at Ural Locomotives have been applied to designing a mainline electric freight locomotive with an induction traction motor (model 2EC10), one of the most powerful DC electric engines for the 1,520 mm gauge lines. The electric locomotive can drive trains weighing over 9,000 tons. That is twice as much weight as the commonly used VL (a class of Australian diesel locomotives built by Ateq, Melbourne) locomotives.

Leveraging digital technologies

In the near future the company is going to deploy the Teamcenter Requirements Management module to consolidate and apply the requirements to train design, safety, efficiency and noise, and to generate new product configurations as these initial requirements change. The Teamcenter CAD Data Management module will also be deployed for efficiently coordinating engineering analysis data, easily searching and re-using analysis results, and creating and managing complex assemblies.

Siemens' advanced digital technologies have helped Ural Locomotives develop and follow the best global practices for railway engineering. ■

“Working with Teamcenter, the designers concurrently develop all the components in a single model and can see any updates made by other stakeholders. Such an approach reduces errors that are hard to identify with other design procedures and would likely only be found once the product was assembled.”

Dmitry Khaziyev

Senior Design Engineer, Locomotive Underframe Department, Mechanical Design Division

Ural Locomotives

How to...

Set up and calibrate after-treatment system models

The implementation of continuously evolving regulations, toward a drastic reduction of vehicle emissions, raises new engineering challenges and the need to more widely deploy exhaust system simulation over the development cycle. This cannot be done without a strong combination of modeling capabilities and methodologies supported by application-specific tools since after-treatment simulation remains as combustion, a hot topic involving complex cross-coupled phenomena.

The benefits of using system simulation, to support the development of exhaust lines including pollutant abatement devices as well as their evaluation in a vehicle context, have been documented and demonstrated on many occasions. However, the physical modeling of the catalytic converters using OD/1D approaches remains a delicate task which, in most cases, requires specific competences hardly compatible with a large deployment.

The modeling capabilities of Simcenter Amesim are leveraged by an application-oriented tool, the which supports and guides the user in the set-up and calibration of the aftertreatment system models, toward an easier adoption by non-experts. Indeed, as soon as the studied exhaust configuration is sketched with determined location of monoliths, pipes, gas analyzer and sensors, a well-structured methodology can be applied.

After fixing the monolith geometry in terms of number of cells, wall thickness and monolith apparent density, the kinetic scheme involved in each of the monoliths is to be defined. This is a complex process for several reasons. First, the list of species to be tracked in



Figure 1: Simcenter Amesim Exhaust calibration tool is an interactive interface with a step by step workflow

the conversion process is to be defined and the associated chemical reactions as well. In addition, changes in emissions regulations impact designs and loadings which tend to increase the complexity of the pollutant conversion chemistry. Hence, developing the right kinetic scheme becomes a challenge, especially for non-experts.

To make this step more accessible for broader user profiles, predefined chemical schemes for main known applications are provided in the tool in the form of a database of chemical reactions (three-way catalytic converter, diesel oxidation catalyst, selective catalytic converter...).

These predefined sets of reactions are provided with their rate law formulas (Langmuir Hinshelwood) which can be customized according to the studied case. Default values are given for the two Arrhenius parameters (pre-exponential factor and activation energy) and can be used as a starting point for the calibration study.

User-defined species and reactions can be added to ensure more flexibility in case of the reaction scheme is already defined.

Once a kinetic scheme is determined, the actual model calibration process can start. The first step is related to the handling of the available test data.

The experimental data needed for the exhaust model calibration can be generated either by a synthetic gas test bench or by engine/chassis dynamometers. They are uploaded in the tool and will be used as reference for the actual model parameter tuning step. Their quality and consistency are a trigger point for an efficient model calibration. Hence, the test data should be analyzed and pre-processed carefully to ensure the calibration pertinence.

The experimental data required are mainly mass flow rates, temperatures and species concentrations as a function of time. According to gas analyzer's operation, a gas sample is

taken from exhaust pipes, crosses the sample lines before being analyzed by specific probes: this operation induces a time response on measured concentration signals, depending on the specie (sensor location in the analyzer). However, it is critical to get all signals well-synchronized prior to any detailed analysis or calibration work.

The gas compatibility evaluation can support this synchronization process. An atomic mass balance (C, H, N, O) is used in order to produce some criteria which should be around 100 percent. It enables the consistency of the measured concentrations to be checked as well as the relevance of the signal synchronization settings.

Finally, experimental data can also contain some noise which also make the application of optimization algorithms more difficult during the calibration step.

Using Simcenter Amesim exhaust calibration tool, import data step, analysis, synchronization and filtering features, engineers benefit from better data consistency, as pre-requisite to a fine calibration using optimization algorithms.

Experimental curves visualization also helps understanding involved phenomena. For instance, in Selective Catalytic Converter applications, nitrogen oxides react with injected ammonia. In case nitrogen oxides emissions decrease while urea is not yet injected, those capabilities provide information about the monolith preconditioning with ammonia and an appropriate initial coverage parameter.

Once experimental data is processed, the actual model parameter calibration

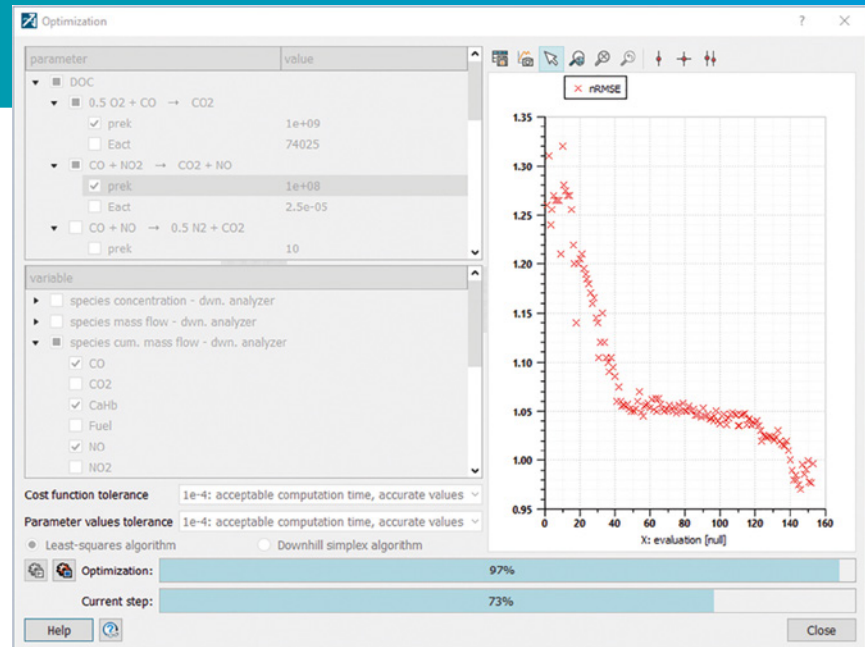

Figure 2: The optimization feature helps the kinetic model calibration

step can take place. The purpose of this stage is to find/optimize chemical model parameters in order to get simulation results fitting with test data.

In practice, the calibration study can be performed either by changing Arrhenius parameters manually which actually helps to understand the couplings between individual reactions or make use of optimization features.

Optimization algorithms combined with appropriate definition of cost functions, adapted to the handling of pollutant conversion data can help to find optimum kinetic parameters in a more automated manner. The actual application of optimization requires a very fast processing of the simulation. In the case of Simcenter Amesim, CPU-efficient implementations of the monolith models can be combined with standard batch and parallel processing which makes optimizations possible in a very reasonable time.

Finally, this exhaust line setup process aims at developing predictive after treatment system models which can

support different type of analysis: define the right devices and architecture, support control development and validation (plant model), or can be leveraged for broader system analysis.

For instance, fast CPU time ensures full compatibility with real time simulation required for hardware-in-the-loop simulation.

On that basis, the exhaust line model is ready to be integrated to models including vehicle subsystems and controls and apply to evaluate the system attributes including emissions over different driving cycles scenarios including RDE. This can be seen as an important support toward the optimization of electrified powertrain where the engine frequent shut-off have a major impact on the catalytic converter thermal state and conversion efficiency. ■

E2M Technologies

Global simulator designer and manufacturer adopts Simcenter to speed up product development



Siemens Digital Industries Software helps E2M Technologies reduce product lead time through virtual testing

Disrupting industry

Among the many requirements of becoming a commercial pilot are hundreds of hours in the classroom, in the air and up to a few dozen hours in a simulator. In today's fast-paced world, complex motion simulators assist with learning and perfecting the many specialized tasks associated with flying, entertainment, ground vehicle simulation and testing. These systems generally have long lead times, undergo many revisions and take considerable time to deliver the finished product.

Founded in 2007 in Amsterdam, Netherlands, E2M Technologies is impacting industry by leveraging their quick-to-market, customizable motion systems for simulators. From conceptual phase to feasible end-product in a minimal timeframe, their durable, smooth electronic actuation products are used for flight simulation, ground vehicle simulation and the entertainment industry.

E2M Technologies' products and services are provided by cards PLM Solutions, a Siemens partner. Through this partnership, E2M Technologies utilizes a variety of Siemens Digital Industries Software solutions, including Simcenter™, NX™ and Teamcenter® to design, test and stay organized when creating new products for customers. While the company is relatively new to the arena, they already have a wide range of systems for motion simulation, including the largest electrical system in the world.

"We have three patents, which for such a young company is a big achievement," says Rabih al Zaher, group leader



mechanical department, E2M Technologies.

Starting with Simcenter 3D

E2M Technologies engineers apply the latest production techniques to develop state-of-the-art motion systems for simulators used in various industries. To create the best products possible, E2M Technologies starts with Simcenter 3D Motion software.

"With every new project, we start with our skeleton design which is made in Simcenter 3D Motion," says Roald Munnig Schmidt, senior design engineer, E2M Technologies. "We can quickly assess the movement of a customer cabin to check whether it fits in an existing building. During the design phase of a new system, we use Simcenter 3D Motion to check for internal collisions and easily visualize these challenges in search of the best solution."

E2M Technologies understands the advantages of using multiple Simcenter products. "Being completely integrated with the NX/Teamcenter design environment makes Simcenter 3D Motion easy to use and access," says Munnig Schmidt. "Insights gained with motion can easily be incorporated in the design and rechecked. This way it is just part of the engineering process without interrupting the design process."

Eliminating extra steps

Munnig Schmidt views the application of Teamcenter as a major upgrade for the company. "Using the Teamcenter database, we can look up parameters or specifications, eliminating the step of repeating work that has already been done," he says, "Using Teamcenter, we are able to re-use parts and assemblies, and perform updates without tampering with older designs." He goes on to say, "This makes the journey from concept phase to something that is

already sort of feasible really quick. It also helps us to communicate with our customers because we can show them where we have minor design changes. Then we can change them through our integrated system, which will lead to the best end-product."

Jack Wever, senior structural engineer, E2M Technologies, realizes the importance of minimizing extra tasks to focus more time on the end-result. Having a dedicated server to solve calculations and keep the process running smoothly is vital to E2M Technologies' ability to meet customer demand with high quality work. Their server is equipped with a Simcenter™ Nastran® enterprise solver, enabling them to queue and solve analyses without slowing workstations and continue to keep the workflow moving at a rapid pace.

"By having a dedicated server, we can perform pre-post tasks on our own workstations while the server solves in parallel," says Wever. "Not having to

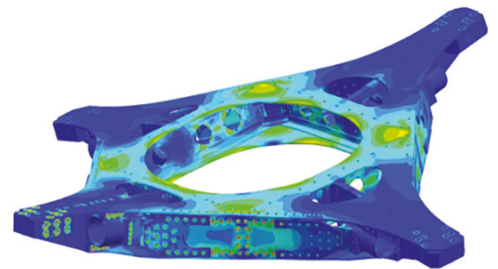
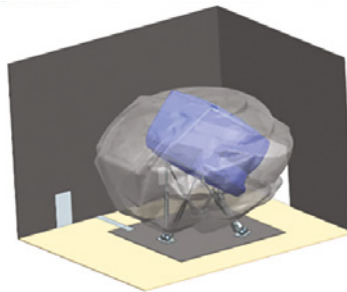

slow down these workstations enables us to achieve maximum efficiency."

Ability to adapt

"Different FEA models with different levels of detail are used throughout the design process to guide the designer towards an optimal solution in terms of performance and production costs," says Wever. "From feasibility studies in

early concept phase, to detail analyses for production approval."

Changing physical prototypes in the middle of manufacturing can lead to high costs and delayed delivery. With Teamcenter, E2M Technologies can communicate easily and effectively to keep a project on schedule.

"If they suddenly decide, 'We want to have a small change there,' E2M Technologies is capable of immediately implementing those changes without affecting deadlines," says Wever. "This is possible using Simcenter combined with Teamcenter software. We can quickly communicate with our design engineers. As model changes are sent back to our department, we can update the models and verify where stresses are still acceptable.

"The strength of our company is being flexible to design changes at any stage of the project and still meet the deadline. We can really do that with the help of Simcenter 3D and Simcenter Nastran." ■



BAR (Ben Ainslie Racing) Technologies

BAR Technologies uses Siemens Digital Industries Software solutions to create a new class of sport yacht





Siemens solutions help take racing performance into the leisure sector

Sleek, racy and efficient

With an optimized hull and dynamically adjusting foils that enable greater efficiency over a wider range of speeds, it's a boat designed for both performance and comfort. The Princess Yachts R35 was made possible by BAR Technologies, which uses highly specialized techniques and processes when designing an America's Cup racing yacht. BAR Technologies is now offering its unique expertise to customers across the marine industry.

Princess Yachts first approached BAR Technologies with the aim of creating a completely new design that would attract people who had not previously considered buying a boat. The new design was to be an entry-level purchase: a day boat that was exciting yet easy to drive. Paul Mackenzie, director of product development at Princess Yachts, explains: "We have a very high percentage of return customers and once they are in the Princess family they tend to move up our range, so introductory boats have always been important. However, most people who buy a Princess are already boat enthusiasts. We were looking to expand our potential market, closing the gap between boat owner and car owner, with a product that could be positioned alongside a super car."

Simon Schofield, chief technology officer at BAR Technologies, adds "Our brief was to devise a technically driven design with increased efficiency and accessible performance, yet retain the luxury and quality that Princess is known for. The digital modeling and simulation tools and techniques that we have established over several years were critical to the fulfilment of the brief."

The integrated virtual environment at BAR Technologies uses solutions from Siemens Digital Industries Software. These include NX™ software for product



“Technology from top-level racing gives this boat the edge.”

Paul Mackenzie
Director of Product Development
Princess Yachts

design, Teamcenter® software for data management and the Simcenter™ software portfolio, which includes Simcenter™ Nastran® for engineering analysis and Simcenter STAR-CCM+ software for computational fluid dynamics (CFD) analysis.

A new application for foiling technology

“On an America’s Cup yacht the hydrofoils are there to lift the hull out of the water,” Schofield says. “On this project, the foils are combined with a unique hull form to support a portion of the displacement. Additionally, these foils are automatically adjusted to provide active roll and pitch control, providing better seakeeping characteristics and lower fuel consumption.”

From designing and optimizing a racing yacht to very tight timescales, BAR Technologies has developed various innovative processes. For example, the team has a unique method of using the

scripting capabilities of NX to generate numerous potential hull geometries, then harnesses the power of Simcenter STAR-CCM+ to optimize the hull through rapid static and dynamic simulation.

The hull and foil combination is developed using a tailored optimization methodology. This approach is based on large-scale batch creation of parametric geometries using NX modeling and scripting capabilities, highly refined Simcenter STAR-CCM+ simulations, and advanced artificial intelligence neural networks. "Within NX we parameterize the hull and foil geometry and use a scripted process which allows automated creation of thousands of geometries within hours," comments Paul Gliddon, naval architect at BAR Technologies. "As part of this process, Simcenter STAR-CCM+ CFD simulations are automatically undertaken on these geometries and the resulting CFD data feeds our neural network-based optimization techniques. This enables us to accurately predict and interrogate the performance of millions of potential hull forms extremely quickly."

Collaborating with precision

Pininfarina, the Italian company known for luxury automotive design, styled the exterior, producing surfaces that BAR Technologies parameterized using NX. The Princess Yachts team, which also used NX, designed the internal systems. BAR Technologies' responsibilities included structural engineering, which relied on Simcenter Nastran.

Development depended on extremely close collaboration, with Teamcenter managing data transfer between Princess Yachts and BAR Technologies. The data sharing integrated complex electrical and mechanical fit-out such as the foil components and associated control systems. At the same time, it was imperative to maintain the ergonomic characteristics and luxury feel of a Princess design.

To maximize the time available for hull optimization, BAR Technologies undertook structural engineering and detailed design in parallel with the optimization process. Through the parametric capabilities of NX, the team was able to refine the master assemblies with the latest optimal



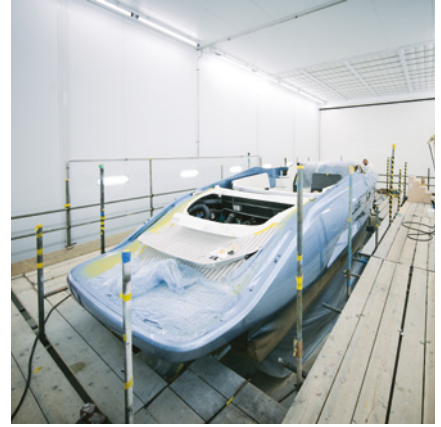

geometry until very late in the design process with the knowledge that detailed design elements and drawings would be automatically and accurately updated.

A first for the maritime industry

The project took 18 months from concept through prototype testing to the highly anticipated launch of the R35 at Cannes in September 2018. "This is the first small boat that Princess Yachts has produced in a very long time and we are delighted," comments Mackenzie. "A huge amount of excitement was generated by the launch and we have a very healthy order book. From a brand perspective, the R35 has been incredibly successful

in opening Princess Yachts out to a wider audience."

"With the R35 we achieved a reduction of up to 30 percent in fuel consumption at cruising speeds, with no impact on top speed," says Schofield. "In addition, the actively controlled hydrofoils allow for greater accessibility of performance. With a choice of sport and comfort modes, the skipper can tailor the seakeeping characteristics of the vessel to suit conditions."

Leveraging PLM tools and techniques

"Technology from top-level racing gives this boat the edge," says Mackenzie. "Using foil technology for the first time was a huge step for Princess. The R35

“This enables us to accurately predict and interrogate the performance of millions of potential hull forms extremely quickly.”

Paul Gliddon
Naval Architect
BAR Technologies



was also our first boat to be made in full carbon fiber for better strength-to-weight ratio, and the first in a long time to use petrol for stronger performance. In addition, we produced a prototype, which is unusual in the marine industry. Given the extent of collaboration and refinement, we achieved a huge amount in a very short time. We have learned a lot from the specialists at BAR Technologies and we continue to work with them.”

BAR Technologies continues to develop its intellectual property (IP), design tools and techniques with the aim of remaining at the forefront of marine design technology. “One of our particular strengths is our optimization processes, and the Siemens suite of tools is fundamental to these,” Schofield concludes. ■

“One of our particular strengths is our optimization processes, and the Siemens suite of tools is fundamental to these.”

Simon Schofield
Chief Technology Officer
BAR Technologies



Rate shaping the future

CFD based optimization of multi-pulse injection strategies delivers a cost-efficient methodology to cope with the complexity of future gasoline direct injection combustion systems

By Simon Fischer, Technical Marketing Engineer

To stay competitive with emerging alternative powertrain solutions, the gasoline engine needs to undergo significant improvements in thermal efficiency and reduce particulate matter emissions. Yet, any measure to achieve these goals comes at the penalty of increasing complexity of the combustion system, implying a direct increase in development cost and time-to-market. Therefore, a key to modern gasoline direct injection development is the ability to virtually explore more system configurations and operating strategies, building less physical prototypes and reducing corresponding cost intense physical testing.

Among the various high-potential measures to improve gasoline direct injection fuel economy and reduce emissions is the usage of multi-pulse injection strategies aimed at ideal fuel

distribution and turbulence conditions for optimum combustion performance. However, a reliable virtual shaping of injection rate profiles requires accurate high-fidelity computational fluid dynamics (CFD) simulation technology and a robust and capable design exploration tool catering for the automated intelligent search of better strategies in a highly complex and often constrained design space. As significant progress has been made in both fields over the past decades and thanks to continuously increasing computational power, even a comparably computationally expensive simulation like in-cylinder CFD has become a candidate for true design exploration.

Based on that engineers at Siemens Digital Industries Software established a fully integrated CFD-based design exploration methodology to find better

injection strategies for gasoline direct injection engines.

Exemplarily, the goal of the first demonstrator study was to find injection strategies that maximize the combustion efficiency of a generic gasoline engine operated under full load stoichiometric homogeneous charge conditions at 4,000 revolutions per minute. The derived targets to achieve this goal were to maximize both turbulent kinetic energy and fuel distribution homogeneity in the combustion chamber at ignition timing, thereby ensuring an ignitable mixture at the spark plug. Further constraints were specified for the maximum fraction of fuel flowing back into the intake port and non-vaporized liquid fuel residual in the chamber at ignition timing assuming they are a major contributor to particle emissions. A generic fuel injection pulse train was parametrized allowing for any number between one to four trapezium spray pulses, with a variation of injection start, respective pulse durations and intervals between any two pulses. For each of the strategies a transient CFD simulation of the mixture preparation from intake through compression up to ignition timing was carried out using fully automatic in-cylinder simulation technology. Covered physics include moving piston and valves, spray injection and vaporization, droplet-wall interaction and wall wetting as well as the turbulent flow and air-fuel mixing.

A tool-embedded optimization algorithm was used which is characterized by its hybrid and adaptive nature, in other words automatically using a blend of state-of-the-art optimization algorithms combining local and global search strategies and tuning itself to the design space during the search. This is very cost-effective in both complex and simple problems. Consequently, no optimization expertise was required to conduct the study and the only input that is required to the optimizer is the number of injection strategies to be assessed.

By this means, 80 different injection strategies were studied fully autonomously on a high performance computational cluster.

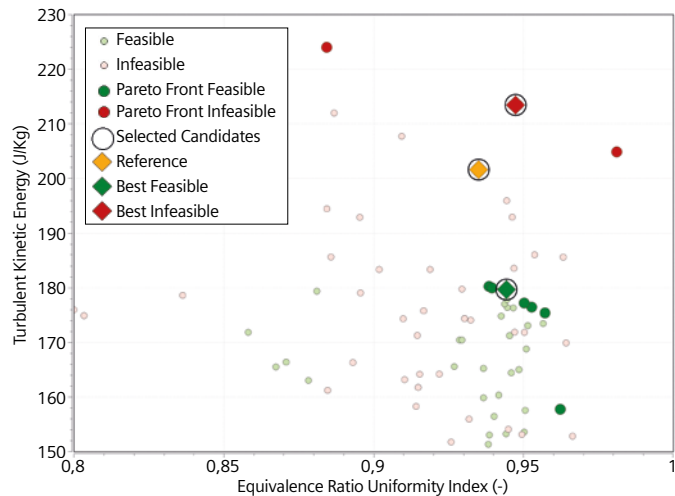

Figure 1: Trade-off between turbulent kinetic energy and fuel distribution homogeneity at ignition timing for 80 different multi-pulse injection strategies

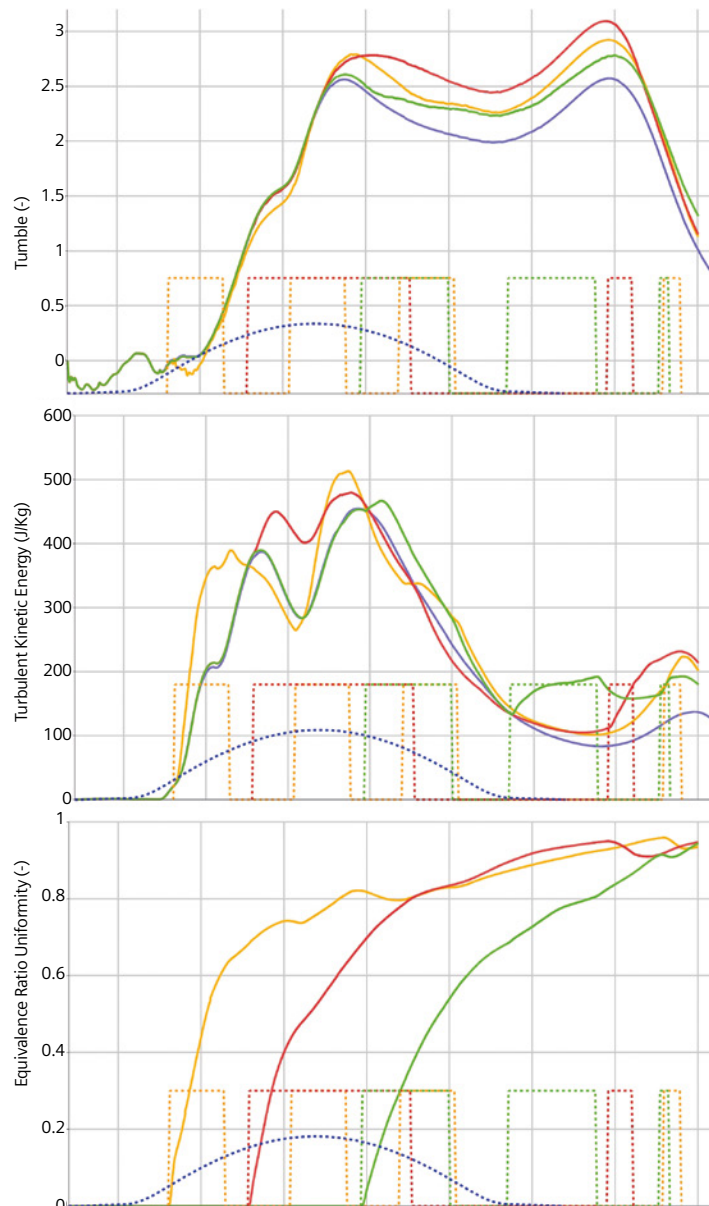

Figure 2: Transient evolution of averaged tumble, turbulence and equivalence ratio uniformity for three selected candidate injection strategies (dotted lines)

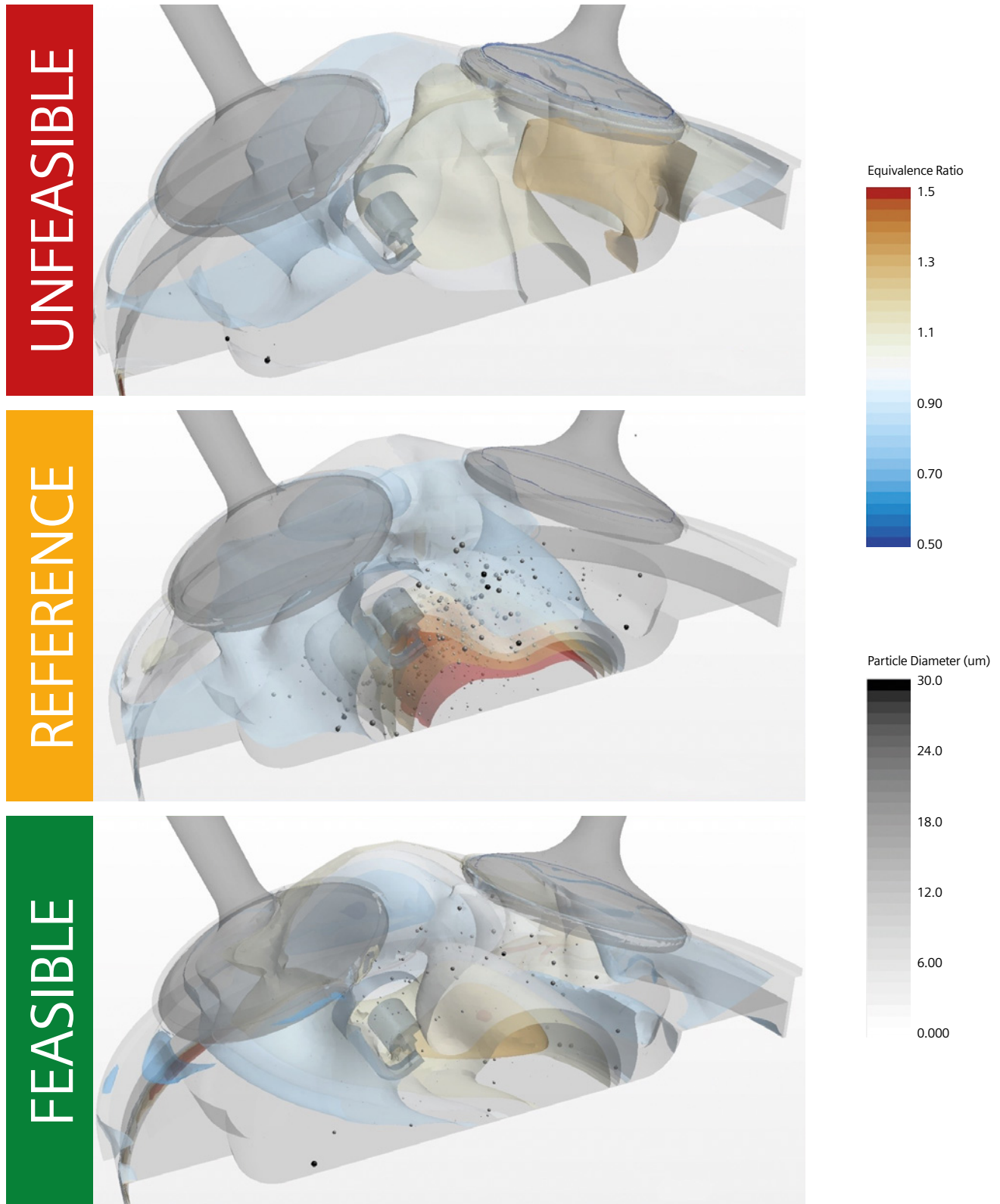

Figure 3: Isosurfaces of fuel equivalence-ratio and liquid fuel droplets at ignition timing for three selected candidate injection strategies

A distinct trade-off between the turbulent kinetic energy and fuel homogeneity became obvious. In first order, early pulses tend to lead to better air-fuel mixing with no direct effect on turbulence levels at ignition time,

whereas later pulses may directly boost late turbulence levels at the cost of decreased mixing time available. At the same time very late pulses result in non-vaporized liquid fuel in the chamber and non-ideal timing may cause fuel to

be recirculated into the intake-port during a back-flow phase right before intake valve closure.

While many of these effects are to be qualitatively expected from first sight, the algorithm manages to find - otherwise hard to identify - optimum compromise solutions in this space of numerous competing objectives. Despite the strict requirements on valid solutions several feasible strategies were found using the proposed method.

A detailed analysis thanks to CFD allows for a deep insight into how the spray impacts the intake jet and fuel distribution in dependence of the respective injection timings. The big data analysis reveals how outstanding strategies manage boosting the fuel uniformity and tumble with ideally timed early intake-phased pulses, thereby improving the later turbulence level as the tumble breaks down, at the same time ensuring ignitability and a further boosting turbulence with a perfectly timed late pulse.

All this while simultaneously mitigating fuel related constraint violations as much as possible.

Based on these insights from the automated design exploration the engineers were able to choose among a series of better performing strategies each of which offered unique benefits.

In comparison with the four pulse-reference strategy, two further strategies stand out: a three pulse strategy, where the intake port fuel and liquid fuel present at spark timing are reduced by eighty percent and sixty percent respectively, at a slight cost of reduced turbulent kinetic energy, and another one consisting of two pulses improving vaporized fuel present in the engine, levels of turbulent kinetic energy and fuel homogeneity, all simultaneously, at acceptable penalty of fuel back flow to the intake port.

Which one might be the “right” choice remains an engineering challenge that typically cannot be answered by any algorithm. It is the synergy of efficient automated identification of high-performing strategies in a highly complex design space combined with

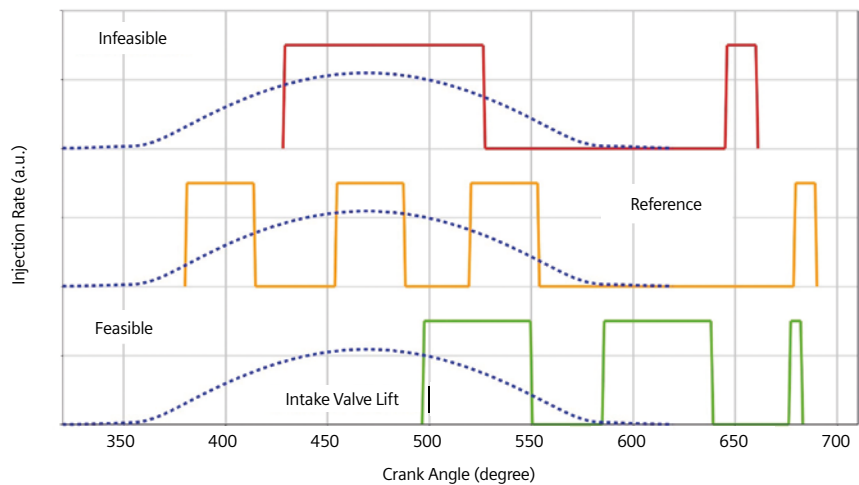
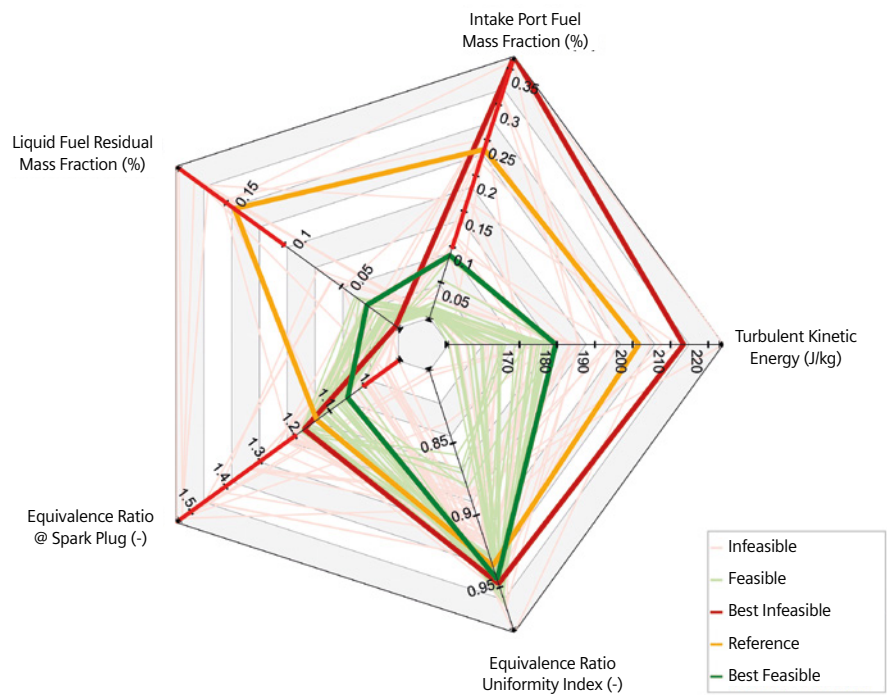

Figure 4: Performance metrics of all studied injection strategies (top) and selected interesting candidate strategies (bottom)

the engineer’s experience-based final assessment of better-rated options that adds significant value to the engine optimization process.

While the study at hand has proven the potential of CFD-based rate shaping for gasoline direct injection engines, Siemens engineers only see it as a starting point. Thanks to a fully embedded automated workflow, extensions to spray targeting, valve timing, or piston shape optimization are only a few mouse-clicks away, offering a toolset to not only shape future injection profiles but the complete gasoline direct injection combustion system. ■

Design of a Sodium-Water Reaction Pressure Relief System of Prototype Generation-IV Sodium-Cooled Fast Reactor



By Sun Hee Park and Ji-Woong Han, Korea Atomic Energy Research Institute

With the growing level of carbon dioxide (CO₂) in the atmosphere, it is important to understand the biggest contributors and investigate options for reduction. One of the largest sources of carbon dioxide is power generation, an area that will only continue to grow as the world's population does the same. Among the many potential emerging technologies, nuclear energy is well positioned to contribute as a low emission supply of energy. Over the last few years, several countries have been exploring options for the next generation of nuclear reactors. One option currently in development by the Korea Atomic Energy Research Institute (KAERI) is the Sodium-cooled Fast Reactor (SFR).

Since its establishment in 1959, KAERI has been the only research institute in Korea dedicated to nuclear energy. Over the past 60 years, it has accelerated developments in nuclear technology and made significant achievements, including the localization of PHWR and PWR reactors, the design of a Nuclear Steam Supply System (NSSS) - applied to Uljin Units 3 & 4 - and the design and construction of the multi-purpose research reactor HANARO. As the first research institute of science and technology in Korea and one of the world's best centers of nuclear research, KAERI is building a safe society centered on people and the environment.

What makes the SFR unique is that it uses molten sodium as the reactor coolant. This allows for a much higher power density than a water cooled reactor with a lower coolant volume.

However, one of the dangers of this type of reactor is how reactive sodium is with water and air. A sodium-water reaction is an explosive exothermic reaction that generates hydrogen gas that could result in a pressure increase in the system. This increase in pressure puts the integrity of the entire system at risk. Under normal operation this is never a concern as the sodium of the

closed loop intermediate heat transfer system (IHTS) is circulated between the primary heat transfer system and the steam generator, never contacting air or water.

It is however possible to have a steam generator tube break or leak, which could cause a high pressure wave with corrosive reaction products created and

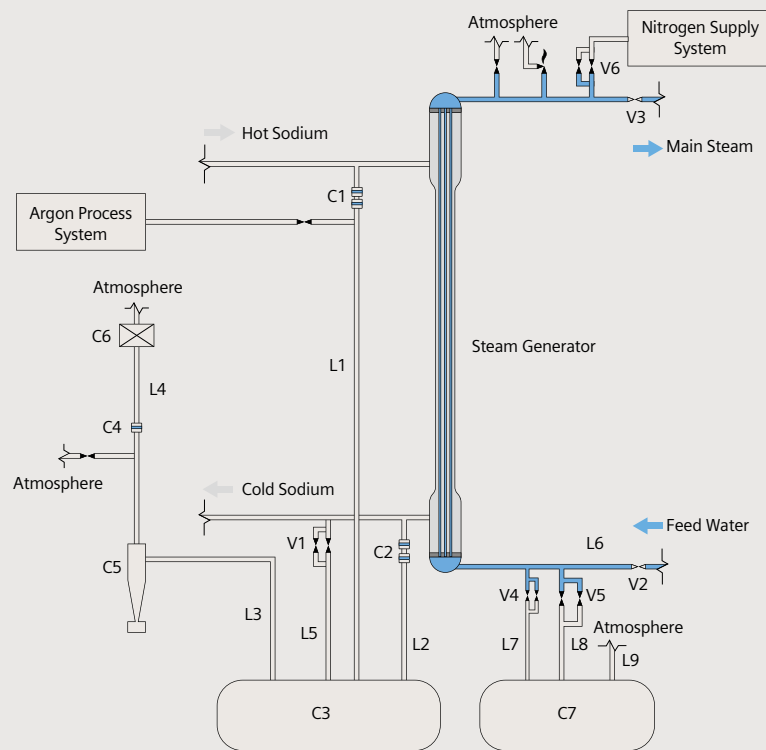

Figure 1. Schematic diagram of a SWRPRS. C1: Hot leg rupture disk, C2: Cold leg rupture disk, C3: Sodium dump tank, C4: Back pressure rupture disk, C5: Gas-liquid separator, C6: Hydrogen igniter, C7: Water dump tank. L1: Hot leg sodium dump line, L2: Cold leg sodium dump line, L3: Gas-liquid separator connection line, L4: Back pressure rupture disk gas vent line, L5: Cold leg sodium dump line, L6: Feedwater supply line, L7: Small diameter SG water dump line, L8: Large diameter SG water dump line, L9: WDT gas vent line. V1: Cold leg sodium dump line isolation valve, V2: Feed water isolation line valve, V3: Main steam line isolation valve, V4: Small diameter SG water dump line isolation valve, V5: Large diameter SG water dump line isolation valve, V6: Nitrogen supply line isolation valve

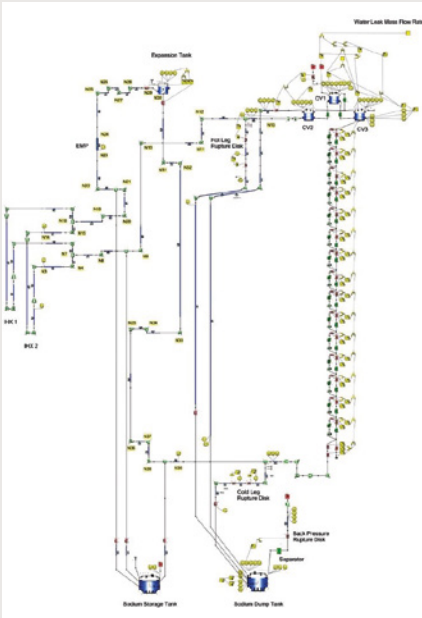

Figure 2. Simcenter Flomaster model of the sodium region of the SWRPRS and IHTS

spread through the IHTS. For this reason it is critical to incorporate a well-designed rupture disk and sodium-water pressure relief system (SWRPRS) to mitigate any large size leak events. For this reason KAERI has used Simcenter™ Flomaster™ software to run a performance analysis of their SWRPRS design. They were able to accurately carry out transient simulations to evaluate dynamic behavior of the fluids inside the steam generator being vented into a sodium or water dump tank in the event of broken steam generator tubes.

Overall the goal of the design is to ensure that, should a large leak event occur, the sodium in the shell side and the feed water in the tube side can both be evacuated separately as quickly as possible. To analyze the system in Simcenter Flomaster, the water and sodium flow distribution systems were modeled in the software while the steam generator was modeled separately. As the simulation was run, the water system model was responsible for calculating:

- Water leak mass flow rate and temperature,
- Gas leak mass flow rate and temperature, and
- Concentration of gases.

Meanwhile the sodium system model was responsible for calculating the pressure of the sodium side shell. These values were then dynamically shared to balance the systems performance.

With the different system models constructed, it was possible to look at two different line sizes of four and eight inches.

To look at the time required to discharge the system the same procedure was followed for both line sizes. Once the event is trigger the water supply pump starts immediately. It is assumed that the time required to start and stop the pump along with the time to open and close the valve is five

seconds. The goal of this is to keep the pressure on the side of the steam generator higher than the pressure on the shell side preventing sodium flow into the generator. To aide this process, nitrogen is injected at a pressure of twenty bar until all of the fluid on the steam generator side is vented.

From the analysis, it was determined that sodium in the shell side of the steam generator and in the intermediate heat transport system was completely vented within fifty seconds and feed water in the tube side of the steam generator was completely vented within two and a half seconds. It was also shown that the pressure on the tube side of the steam generator was always higher than the pressure on the shell side of the steam generator. The use of Simcenter Flomaster to complete these simulations mean KAERI can use the result as the basis for additional design considerations for their Prototype Generation IV sodium-cooled fast reactor. ■

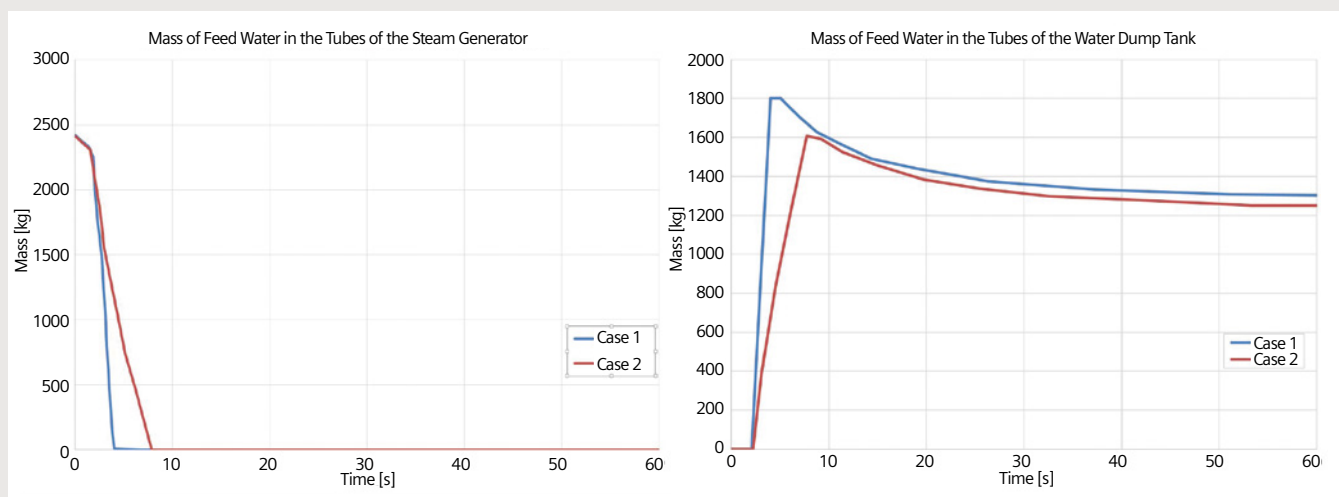

Figure 3. Feed water mass in the tubes of the steam generator and the water dump tank during shut-down

BSH

Home appliance manufacturer optimizes acoustics and vibration product testing with Simcenter Testlab

“Simcenter allows us to strongly correlate simulations with experimental tests that are very important, because without them, the simulations would simply be nice colored pictures.”

Otto Petraška
Head of Vibrations and Acoustics Department
BSH Slovakia



BSH uses Simcenter solutions for advanced sound quality engineering and efficient product development

Washing machines, dishwashers and refrigerators are expected to perform their inherent functions quietly and without drawing attention. With clean clothes, spotless dishes and cold food being a customer's main concern when selecting an appliance, the average consumer has no idea about the competition between leading home appliance product manufacturers to reach optimum noise and vibration levels.

"The importance of this parameter increases yearly," says Otto Petraška, head of vibrations and acoustics department, BSH. "It is even a criterion that can stop the serial production of some of the products."

The BSH Vibrations and Acoustics Department in Košice, Slovakia, is responsible for the acoustic and vibration performance of the electric motors produced by BSH Drives and Pumps in Michalovce, Slovakia.

Formed in 2004, Vibrations and Acoustics department provides services in noise and vibration optimization of household appliances manufactured by BSH under the main brands of Bosch and Siemens. Featuring 16 in-house experts, they serve eight other divisions of Robert Bosch and are involved in the optimization of noise and vibration parameters for all products, from garden tools to electric car engines.

Sound quality for home appliances

The Vibrations and Acoustics department uses a variety of psychoacoustic tools to ensure that premium washing machines and dishwashers meet customer expectations. BSH's Košice laboratory for sound quality uses state-of-the-art tools and techniques to research sound recordings. They measure the sound quality of home appliances by using binaural heads in a high-quality

anechoic chamber to ensure accurate sound representation and analysis.

"We're conducting tests with groups of people for whom we're playing sound samples," says Otto Petraška. "Based on their assessment, we set the acoustic target to meet customer expectations. At the same time, we want to be sure the sound is powerful and has a certain strength without being overbearing."

Rastislav Andrejco, senior center specialist for acoustics and vibrations at BSH, adds, "Customers expect a washing machine to sound like sprinkling water, an extractor hood to sound like wind, and a coffee maker to sound like drops of coffee."

Sound engineering in the early stage of product development

Every component of a product can influence its overall sound. As products are being developed, changes and adaptations are necessary for successful sound engineering. "The sooner we are involved in the development process, the better we can eliminate early product bugs that may produce noise problems at the end of the process," says Otto Petraška. "Of course, it is also more cost-effective than dealing with something at the last minute."

With the collaboration of BSH Drives Development department in Michalovce, this approach is taken for the 14 million electric motors annually produced for all appliances manufactured by BSH under the main brands of Bosch and Siemens. The team in Michalovce is responsible for the design of the electric motors, while the research group in Košice is responsible for the acoustic and vibrational parameters.

Two teams, one digital twin

Košice's acoustics researchers are involved in the early stages of the engine development process. The development team in Michalovce designs an engine comprised of an electromagnetic rotor and stator design



B/S/H/

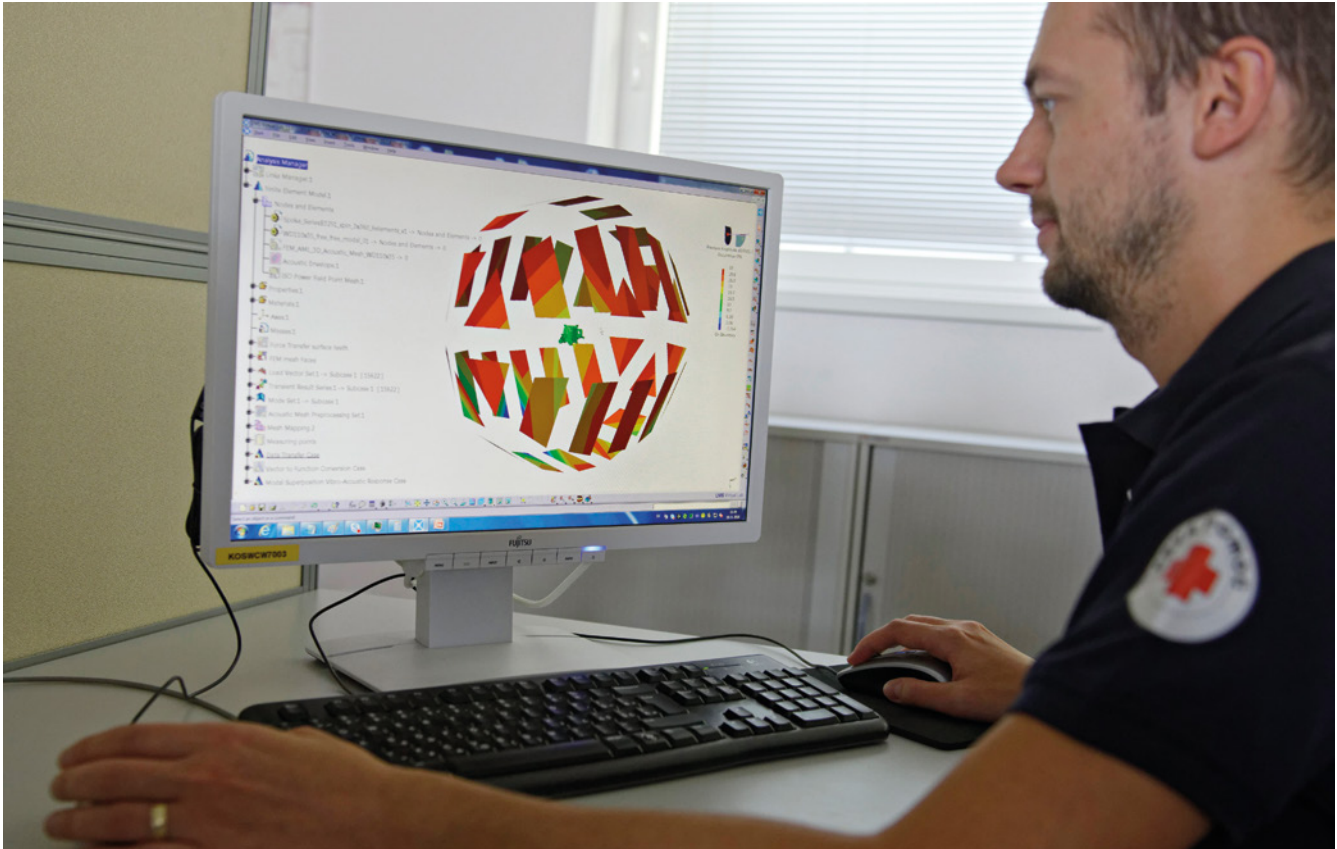

(1D model), creating a digital twin. This virtual model provides the ability to simulate its activity and load and verify all outputs, from physical to operational.

At the same time, the simulation model enables the development team to fine-tune the sound and vibration design parameters before manufacturing a prototype. Using Simcenter™ 3D, the engineer creates simulation models. This allows them to perform vibrational and acoustic

analyses throughout the development cycle. They evaluate the engine's vibro-acoustic characteristics and identify the source of an individual component's noise and vibration. If necessary, they recommend design improvements for the engine's noise and vibration performance without negatively affecting product functionality and production cost. The effect of the design optimization is verified using the Simcenter Testlab™ solution from Siemens Digital Industries Software.

“With Simcenter Testlab, we can intervene at any stage of the simulation chain and find out how the change will be reflected in the basic design,” says Otto Petraška. “For example, when it comes to the engine's structure, when some of its parts create sound we can have a technical remedy. But if the problem arises from the electromagnetic design itself, we return to Drives Development department and optimize the basic design. We experience a number of such loops in the development of a new engine.”

“With Simcenter Testlab, we can intervene at any stage of the simulation chain and find out how the change will be reflected in the basic design.”

Otto Petraška
Head of Vibrations and Acoustics Department
BSH Slovakia

The synergy between physical testing and simulation

The BSH Vibrations and Acoustics



Department began using digital tools in 2008, deploying simulation and test software from Siemens Digital Industries Software's Simcenter portfolio for full data compatibility.

"Simcenter allows us to strongly correlate simulations with experimental tests that are very important, because without them, the simulations would simply be nice colored pictures," says Otto Petraška.

BSH uses Simcenter Testlab in combination with Simcenter 3D simulations. "We perceived benefits of using these interconnected products and we use the synergies offered by them," says Ján Ondrejčák, senior development engineer, BSH. "We notice the effectiveness and user-friendliness of all the Simcenter noise and vibration solutions."

Through experimental testing, the team verifies whether the simulation parameters are correctly set and if the results are reliable. They also use tests

to debug all possible variants and adjustments. "If the simulation shows an optimal result, the product is manufactured into a real prototype," says Otto Petraška. "We can only build a physical prototype when we are sure that we have achieved the best possible result."

With digitalization, development times are continually shrinking. What used to take weeks can now be completed in days; and some time-consuming simulations have been shortened from days to mere hours. As simulation models become more advanced, simulation engineers will be able to anticipate a product's long-term behavior.

"We want to assure the customer that our product will retain the same noise and vibrational performance after years of operation as it did on the day they purchased it," says Otto Petraška. "That builds trust in our brand and we hope to convince them to buy our next generation of appliances." ■

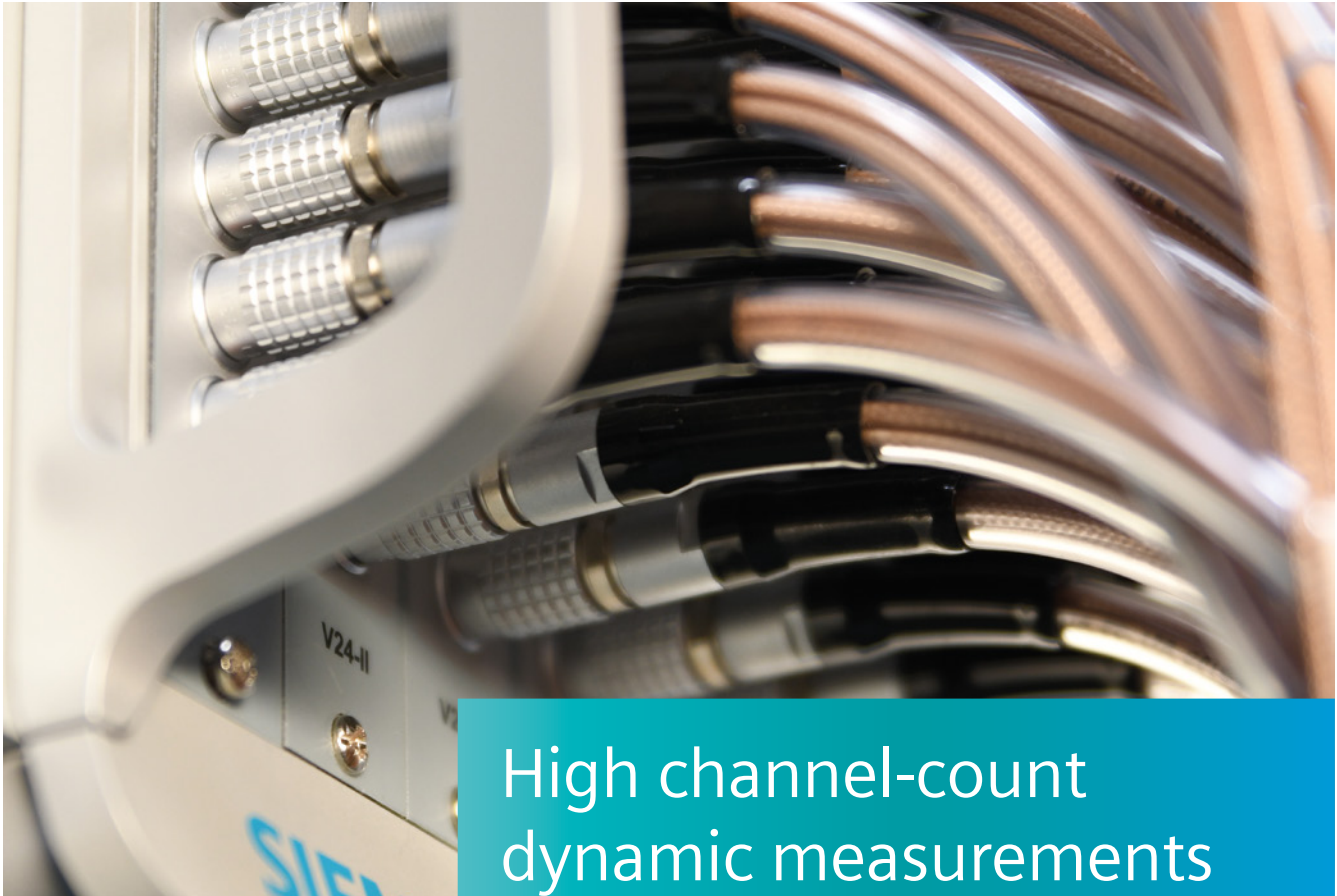

Figure 1: The Simcenter SCADAS hardware and the Testlab software provide integrated signal conditioning capabilities

High channel-count dynamic measurements

Dynamic measurements with hundreds of acquisition channels performed efficiently with Siemens Simcenter Testing Solutions.

A challenging task

Aerospace applications typically require the acquisition and processing of massive amounts of test data. The use of several hundreds of sensors that measure vibration, acoustic, thermal or any other dynamic parameter is necessary to gain better insights into the dynamic response of aerospace structures, as well as to validate their design without missing any hidden flaws.

This might sound easy from a conceptual point of view. However, practically, executing such large-scale test campaigns can be a considerable challenge for test engineers if the right approach is not used. Just think of the instrumentation task for a 70-meter long passenger aircraft in preparation for a Ground Vibration Test (GVT), with several hundreds of external accelerometers attached to it, and the

10-gigabytes of data generated every minute during the test. Now think of how to monitor, process and store this data! Banking on more than 30 years of experience in dynamic testing, Siemens PLM Software has implemented advanced technologies to efficiently support test engineers in these large-scale test campaigns.

Choosing the optimal measurement system for the application

During the development cycle of a full aircraft, spacecraft or even a single component, several dynamic tests must be performed. These tests help confirm predictions from simulation models, validate the design in view of certification or qualification of the specimen under test and help troubleshoot specific issues. The measurement system used during this process needs to offer enough flexibility to cover all these test requirements,

support multiple applications and make use of the widest variety of sensors. The Simcenter SCADAS hardware and Testlab software are fine-tuned for multi-physics applications, including noise, vibration and durability, and provide integrated signal conditioning capabilities that support any kind of sensor, from simple Voltage or ICP sensors to charge or bridge sensors. The system offers a unified platform with great flexibility to handle all acoustic, vibration and durability test requests, making it possible to adapt to late-changes in instrumentation and test planning.

Distributed or centralized hardware configuration

A measurement system typically consists of one or several acquisition modules on to which sensors are connected and their signals conditioned and digitized. A Simcenter SCADAS frame hosting these acquisition modules is connected to the

computer running the application software for controlling the acquisition, processing the data and storing the results. A wide variety of tests must be performed in an aerospace testing lab. The modular design of the Simcenter SCADAS hardware allows to ideally scale the measurement system to the testing need. Independent SCADAS frames can be mixed and matched to assemble a large channel-count system, with perfect synchronization between all channels. Having such a scalable architecture offers flexibility and allows engineers to handle tests ranging from few channels to several hundreds of channels. Distributing systems becomes possible and enables easy set-up and improved accuracy by minimizing sensor cable length.

Managing complex instrumentation plans

Instrumentation of the tested item happens at the beginning of the test campaign before collecting any actual data. It is essential to execute this task properly to match the test requirements and ensure the right level of accuracy. The Simcenter Testlab Instrumentation App, installed on any mobile device, allows the engineer to freely move around the structure while remotely controlling the acquisition software to define the sensor parameters, document the set-up and take pictures of each sensor—which are automatically stored with the corresponding measured data. Transducer parameters, such as serial number or sensitivity, can also be directly read from the sensors and updated in the test channel set-up. This minimizes the risk of manually entering a wrong value and ending up with incorrect measurements.

Dealing with massive amounts of data

Once the measurement set-up has been verified, actual data collection and processing can start. Digital data is streamed at high speed from the acquisition systems to the host computer. When talking about hundreds of sensors on a spacecraft, aircraft or aeroengine, this represents a massive amount of data, especially when sampled at high-speed, and not every acquisition system can deal with such complexity. The system should be properly designed to handle these high throughput rates and make sure no data

is lost during critical tests. Siemens PLM Software provides a dedicated architecture to safely handle high-data streams with virtually unlimited channel counts. By using multiple recording systems in parallel, controlled by a central operator station, data is safely recorded and backed-up with no single point of failure. Data is also seamlessly streamed online on monitoring screens to closely follow the evolution of the test.

In case of satellite vibration qualification testing, selected measurement points are typically used by a closed-loop controller to ensure that the excitation signal exactly matches the test specifications. Having the possibility to acquire hundreds of channels in the Simcenter measurement system in full synchronization with the control system is a great asset. It maximizes the safety of such sensitive tests, does not interfere with the controller system and guarantees data availability at the end of the test.

Providing more physical insights

Online and offline data validation capabilities allow processing of the data during or right after the test and provide quick feedback on measurement quality. For example, data acquired with hundreds of array microphones in an

acoustic wind tunnel is processed during the acquisition and instantly provides a map of the sources on the test object, allowing the engineer to understand the noise generation mechanisms. Verifying the physical meaning of the measured data in that way allows to confirm the validity of the test results on-the-spot. It also allows for the acceleration of the test campaign and make the best use of the limited testing time by testing what is really needed.

In the end, using lots of measurement sensors only makes sense if the data can efficiently be processed and brings additional physical insights into the performance of the tested object. While aviation and space systems continue to grow in complexity, simulation models are also getting more advanced and allow for more complex simulations of multi-physics phenomena. Simcenter Testing solutions combine accurate and reliable data acquisition capabilities with state-of-the-art processing algorithms. Massive amounts of data are methodically managed to provide additional physical insights and enable smarter performance engineering. The Simcenter SCADAS hardware and Simcenter Testlab Software combine the latest technologies to perform large channel-count dynamic measurements accurately and efficiently. ■



Figure 2: Data is seamlessly streamed online on monitoring screens to closely follow the evolution of the test

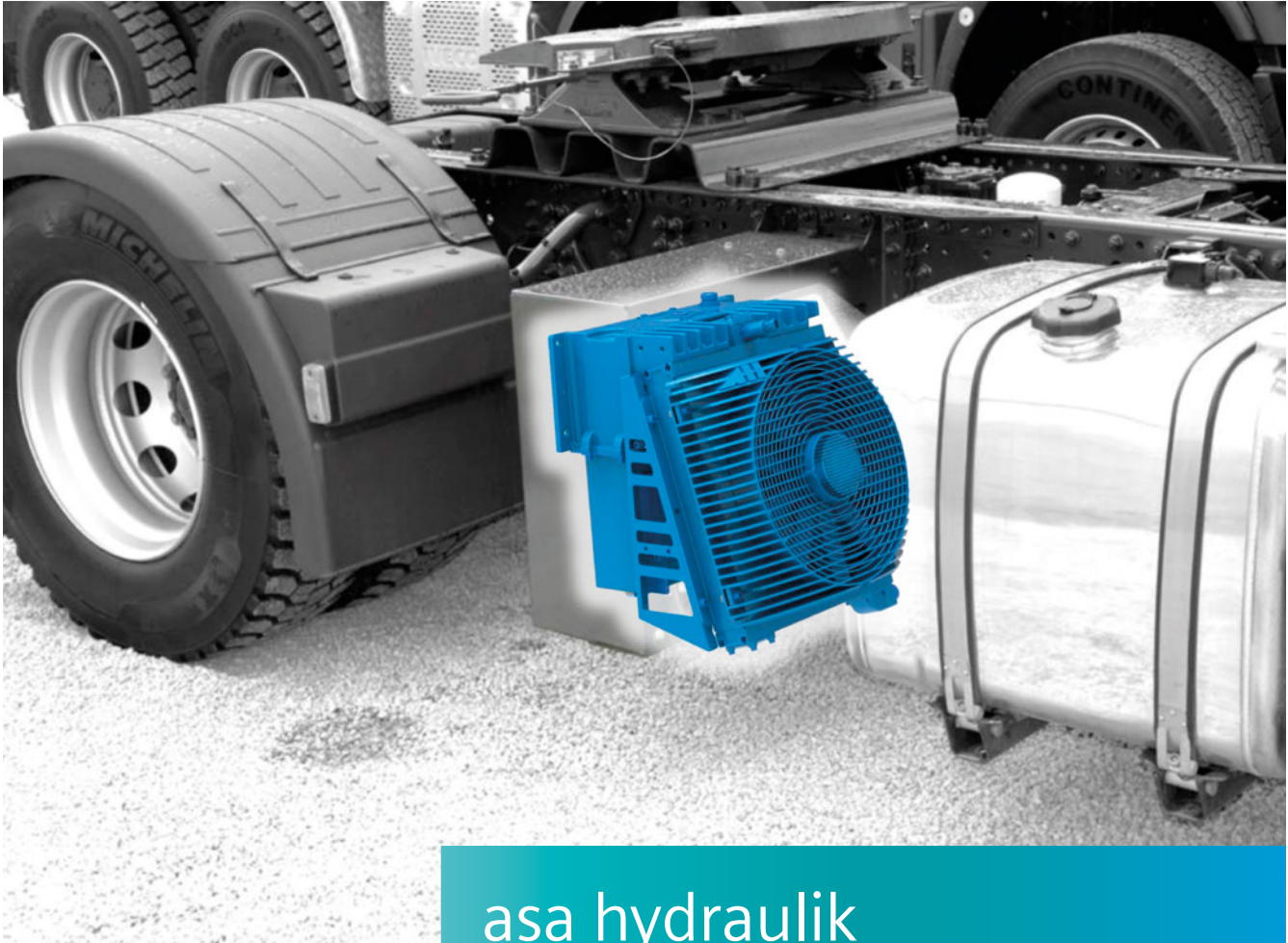

asa hydraulik

Industrial and automotive supplier uses Simcenter 3D to verify and optimize thermal system designs



Siemens Digital Industries Software solution enables asa hydraulik to develop cutting-edge cooling products for electrical applications

Keeping media streams flowing

Stationary equipment such as combined heat and power generation facilities, mobile construction, agricultural machinery and trucks and locomotives require a reliable flow of fuel, air and lubricants as well as heat and coolant.

asa hydraulik GmbH (asa hydraulik) specializes in the design, production and test of thermal systems, connection technology and fluid controls for engine-powered systems. These include standard and custom radiators, tank accessories such as steel and rubber compensators, valves and vibration absorbers as well as pumps and filters.

The company is a leading independent supplier of these critical components. With five manufacturing locations on four continents, asa hydraulik caters to global vehicle and mobile manufacturers and stationary machinery manufacturers. Headquartered in Vienna, Austria, asa hydraulik is also operating a technology center complete with vibration test bench, corrosion test chamber and wind tunnel.

Founded in 1980, asa hydraulik invests at least seven percent of its annual turnover into research and development (R&D). The company believes this policy provides it with a technological edge over its competitors. Early in its history, asa hydraulik was the first company to provide a standard cooler range, which improved cost efficiency and reduced lead times. In 1988, asa hydraulik



developed the first compact and versatile water cooling unit with an integrated filter and plate heat exchanger. In 2000, the company patented the world's first flexible connection system for radiators, followed by the asa rail system, the first flexible mounting and connection system, in 2009.

Tackling the electrification challenge

asa hydraulik's thermal systems product group includes standard radiators as well as several product lines that meet specific requirements for harsh environments or hazardous locations and the H-Ranges of kit components for semicustom comprehensive cooling systems.

Market research reveals that recent technologies used in electricity generation from renewable sources and electromobility still raise concerns related to heat dissipation.

"With nearly 40 years of experience as a technology leader in this field, we felt we should be able to find the proper answers," says Rainer Lindbichler, product manager, asa hydraulik. "In 2017, we decided to add the E-loop series to our portfolio, a new system of cooling

solutions specifically designed to serve the growing electrification market."

Limited time-to-market

Designed to provide a complete system solution for the entire cooling chain, the electrification loop (E-loop) series includes all components required for cooling stationary or mobile power electronics, batteries and electric motors. With plans to unveil the E-loop series at the beginning of the 2019 calendar year, asa hydraulik had little more than 12 months to create marketable products, including design, verification and testing.

For computer-aided design (CAD), asa hydraulik has used the Solid Edge® solution from Siemens Digital Industries Software for over a decade. "This easy-to-learn 3D modeling software goes a long way towards design automation," says Dr. Jürgen Feyerl, chief technical officer, asa hydraulik. "It also comes with functionality that supports the reuse of existing designs, which is an important advantage for our modular products."

Figure 1: asa hydraulik is a manufacturer of thermal systems, connection technology and fluid controls for vehicles and mobile as well as stationary machinery



Figure 2: In 2019, asa hydraulik launched the E-loop series, a new range of cooling solutions specifically designed to serve the growing electrification market

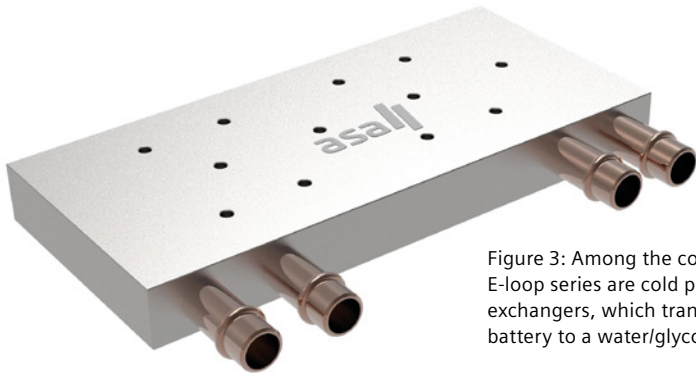

Figure 3: Among the core products of the E-loop series are cold plate heat exchangers, which transfers heat from a battery to a water/glycol circuit

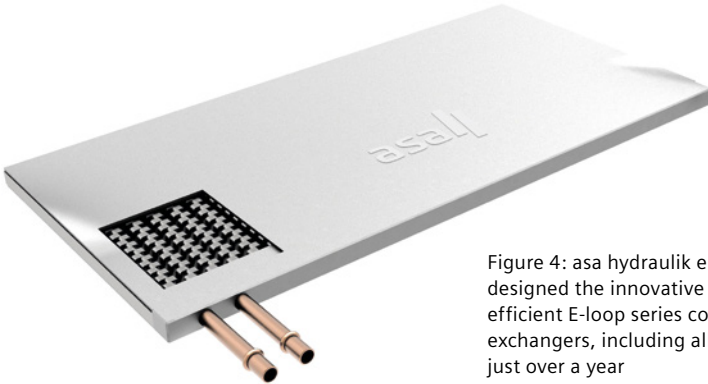

Figure 4: asa hydraulik engineers designed the innovative and highly efficient E-loop series cold plate heat exchangers, including all simulations, in just over a year

Digitalized engineering using Simcenter 3D Flow and Simcenter 3D Thermal

Designing a complex cooling system involves more than just mechanical engineering. To achieve both compact and efficient designs, engineers need to optimize their inner geometry to assure an optimal flow of air and liquids. “Verifying and improving the designs of our cooling systems using physical prototypes would not be practical,” says Lindbichler. “To limit the time and expenditure involved, we use computational fluid dynamics.”

Earlier, asa hydraulik had used the services of ACAM Engineering, an Austrian engineering company specializing in predictive engineering and part of ACAM System automation, a Siemens Digital Industries Software partner. Using various forms of simulation, they analyze the digital twins of their customers’ designs to predict and optimize future product properties.

“This expertise and the software technology used are key factors in the successful design of our products,” says Feyerl. “As we started the E-loop series design project, we decided to enhance our in-house capabilities and invest in the required software.”

Based on a requirement specification reflecting asa hydraulik’s needs, the thermal system design specialists evaluated leading simulation software products. “Three made it into our shortlist,” says Lindbichler. “They all fulfilled our technology requirements and we decided in favor of the solution with the best price/performance ratio: Simcenter 3D.”

To calculate air and media flows as well as temperature progression throughout their designs, asa hydraulik engineers use Simcenter™ 3D Flow and Simcenter 3D Thermal software. This package is part of the Simcenter portfolio, a comprehensive suite of simulation software and test solutions from Siemens Digital Industries Software. Although not limited to fluid behavior, the software is centered on

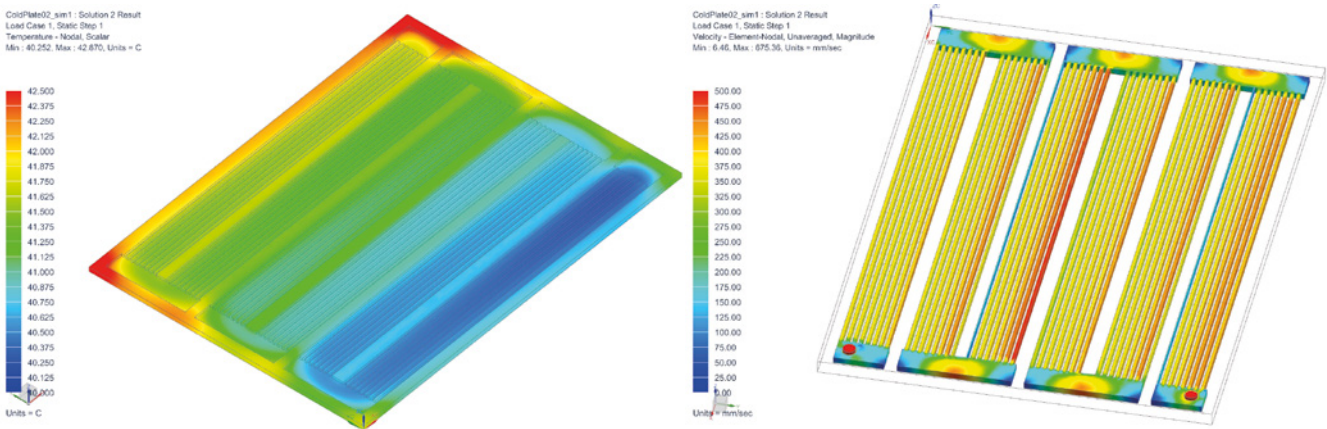

Figure 5: asa hydraulik uses Simcenter 3D Flow and Simcenter 3D Thermal from Siemens Digital Industries Software for computational fluid dynamics (CFD) simulations, optimizing their designs for temperature progression (left) and flow velocity (right), among other criteria

computational fluid dynamics (CFD) to solve and analyze problems that involve fluid flows by successive approximation using numerical analysis and data structures.

Among the selection criteria were the support from the ACAM simulation experts, who are also using Simcenter 3D Flow and Simcenter 3D Thermal and are familiar with asa hydraulik's design issues. Another is the software's built-in, fully parametric 3D feature-based CAD modeler that allows for creating and modifying geometries directly within the software. Simcenter 3D offers full compatibility and associativity with Solid Edge.

"Simcenter 3D has full CAD functionality, allowing us to make modifications within the same software we use for simulating," says Feyerl. "Due to the software's full associativity with Solid Edge, feeding back successful design variations to the original models takes only a few seconds, facilitating successive design optimization."

From virtual verification to real-world success

asa hydraulik started using Simcenter 3D Flow and Simcenter 3D Thermal in 2017. Engineers received training in two stages: following initial Siemens Digital Industries Software training, asa hydraulik's engineers also took a refresher course from ACAM to cover issues that arose in the beginning phases.

"As the software's user interface has an intuitive design similar to the one our engineers are familiar with from Solid Edge, they became productive in a very short time," says Feyerl. "Using Simcenter 3D for CFD simulation also allowed us to greatly reduce the number of physical prototypes we build and analyze."

"Using Solid Edge and Simcenter 3D, we managed to create a new range of cooling products in little over a year," says Lindbichler. "CFD simulation using Simcenter 3D Flow and Simcenter 3D Thermal allowed us to optimize the E-loop series for size and energy efficiency, helping us keep the competition at bay." ■

Kontraktion01_sim1: Solution 2 Result
Load Case 1, Static Step 1
Vorticity - Element-Nodal, Unaveraged, Magnitude
Min: 0.04, Max: 94.30, Units = Unitless

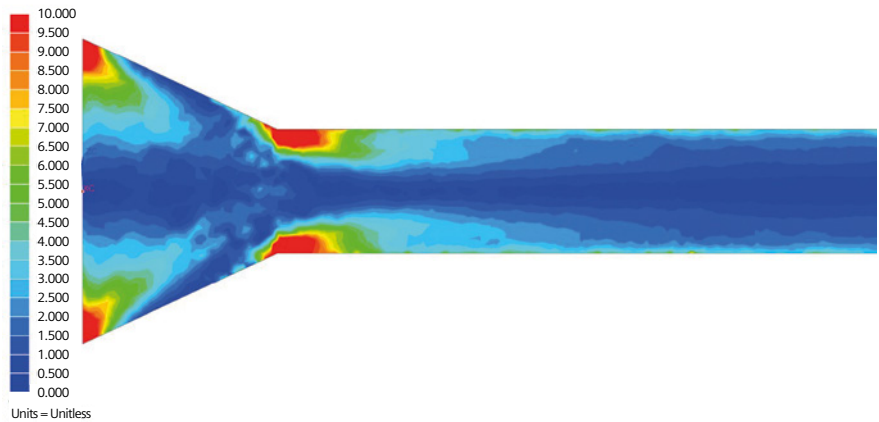

Kontraktion_stp_fem1_sim1: Solution 2 Result
Load Case 1, Static Step 1
Vorticity - Element-Nodal, Unaveraged, Magnitude
Min: 0.04, Max: 34.20, Units = Unitless

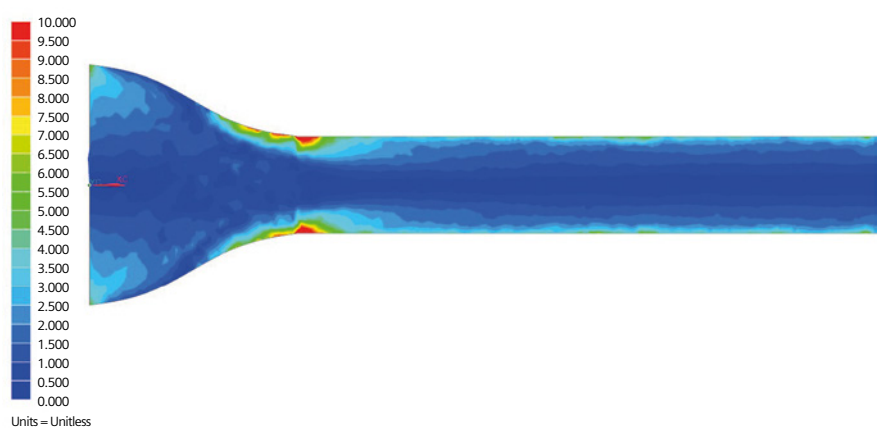

Figure 6: CFD simulation using Simcenter 3D Flow and Simcenter 3D Thermal was used to optimize the geometry of the wind tunnel asa hydraulik built at its headquarters in Vienna, Austria

“Using Simcenter 3D for CFD simulation also allowed us to greatly reduce the number of physical prototypes we build and analyze.”

Juergen Feyerl
Chief Technology Officer
asa hydraulik



How Electromagnetics Engineering Surrounds Us

By Prof David Lowther, McGill University, Canada; and Mentor, a Siemens Business

Have you ever asked yourself what happens to the sensors on your car when it rains? Probably not often, if ever. Yet this is just one of the countless and inconspicuous ways electromagnetic engineering has revolutionized the way we live.

Consider these three examples which are more striking and apparent:

1. Energy and Efficiency. Our modern societies function as a result of being able to create and use electromagnetic energy. The fact that energy can be transmitted between two points through the use of a flexible conducting cable has allowed manufacturing processes to be rethought and factories to be redesigned and relocated.
2. Connectivity has become second nature. Consumers expect high-quality connectivity all the time. This includes fast download speeds on portable devices with lower latency and low power consumption. The same holds true for all facets of industry communications, from communication between satellites and base stations, moving cars and infrastructure and robots and production line control stations, to name a few.
3. With this boom in global communication networks comes more EMI and EMC issues between communication devices, cables and electric wire harnesses. Both radiated and conducted power emissions will need more attention, and there is no doubt properly engineering these high-level requirements will be a challenge.

There are quite a few factors to take into consideration for every electromagnetic puzzle throughout the frequency range.

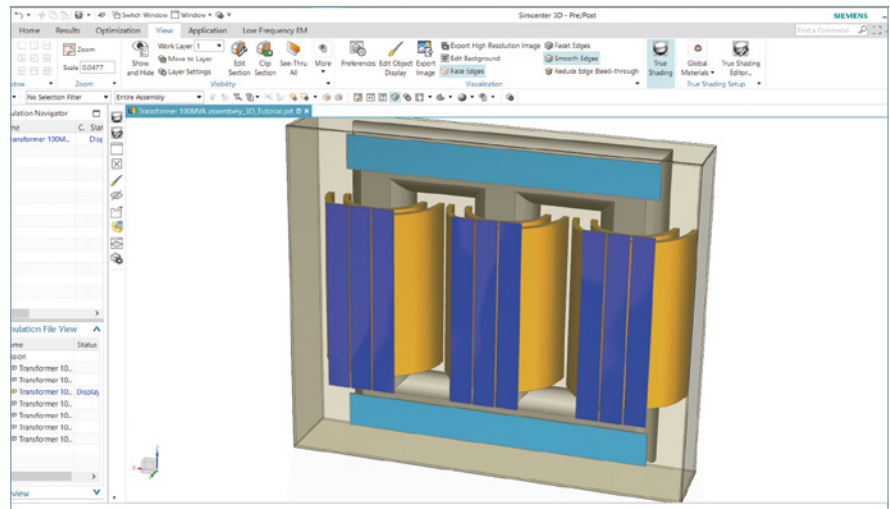

Figure 1: 100 MVA Power Transformer assembly in Simcenter 3D

Electromagnetics is not a one-size-fits-all job, experts typically categorize issues according to whether the electromagnetic field changes are radiated or not. This gives rise to two categories often referred to as high or low frequency electromagnetic problems. Each one has its own typical characteristics and methodology.

All electromagnetic devices have something in common: complexity. They typically require complex shapes to define the desired field structure. The materials used often behave in a non-linear fashion (for example, the relationship between magnetic fields and magnetic fluxes are variable). The field wavelength is much larger than the overall device dimensions. (for example, a one megahertz (MHz) wavelength in free space is about 300 meters so any device with a few centimeters as its maximum dimension will have negligible radiation).

Another major challenge that experts tend to take for granted is scale. Unlike many other areas of physics, the range

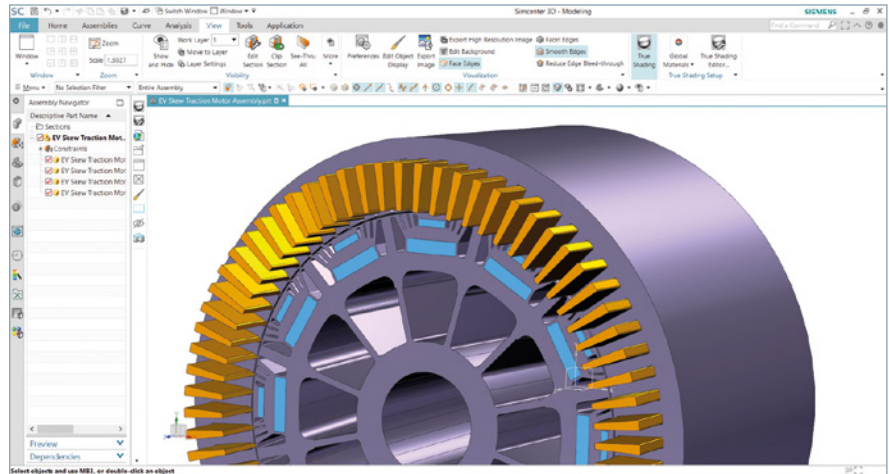

Figure 2: Skewed EV Traction Motor assembly in Simcenter 3D

of scale in a device is huge. As an example, for a transformer you must consider components that are submillimeter in size in a device in which overall dimensions are measured in tens of meters.

This is a scale factor of at least 10,000 to 1. In certain aerospace applications, you have features that are submillimeter in a structure, which is tens of meters in size. How do you handle issues of scalability in both low-frequency and high-frequency scenarios?

From Industry 4.0 automotive and aerospace manufacturing to heavy equipment, innovative electric motor design and development have become industry make or breaks. Not only are

high performance, sustainability and efficiency at the top of the list, significant drivers like the cost of materials, manufacturing and operation are also vital factors in the design and development process. For electromagnetics, accurately representing material behavior and related local loss determinations will help predict machine behavior from a design point of view.

A good example is the traction drive. Engineers have been looking at the use of synchronous reluctance motors to significantly reduce manufacturing costs by removing the expensive permanent magnets (often neodymium magnets). This can lead to a significant loss of torque for certain frame sizes. To

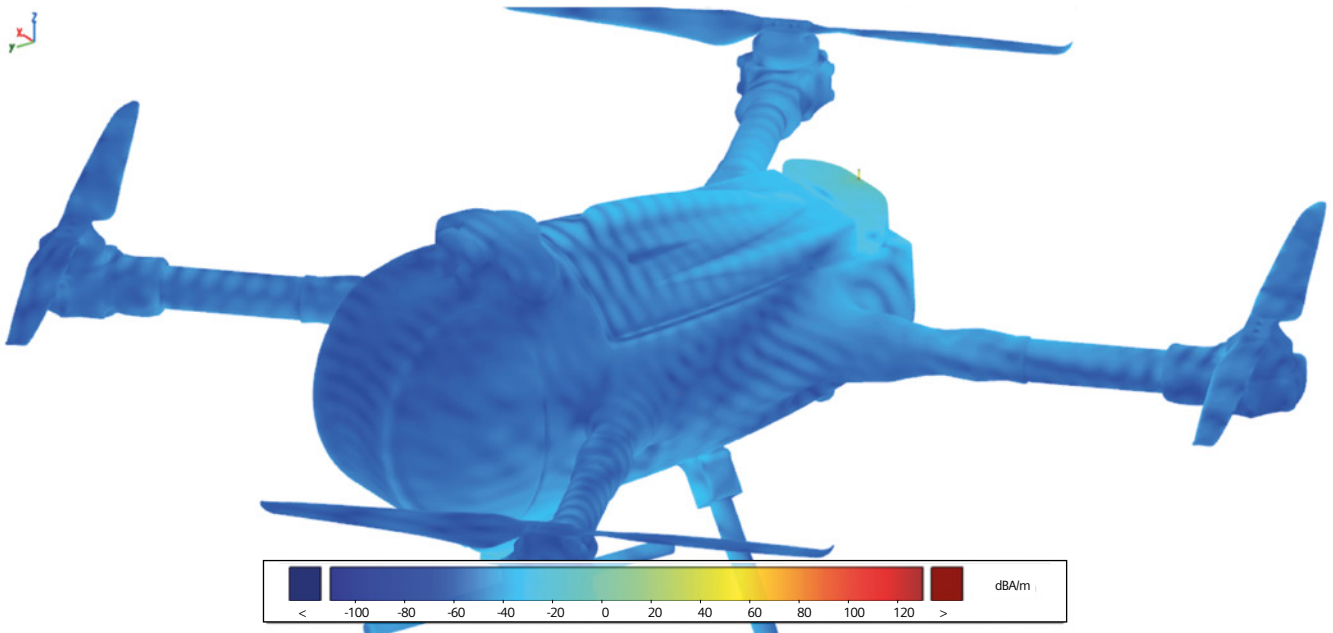

Figure 3: Induced Currents on a Colibri Drone

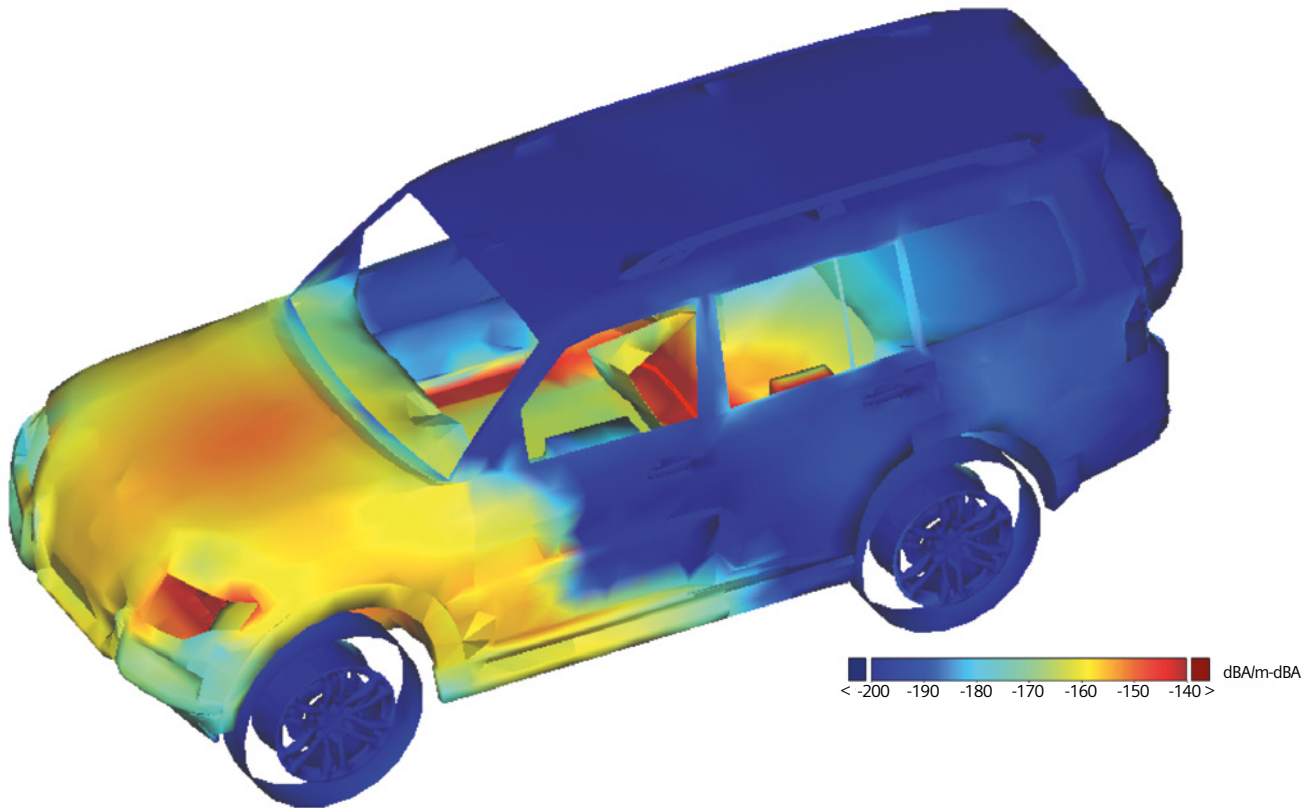

Figure 4: Analyzing the currents induced by the electric power train

overcome this, relatively cheap permanent magnets (alnico or ferrites) can be used within the flux barriers to increase the torque of the machine without significantly increasing costs.

Both automotive and aerospace industries already have regulations for dealing with EMI/EMC issues and electromagnetic shielding is a quite common domain with a wide range of applications. But with the arrival of highly complex products and large-scale EV powertrains in transportation and heavy equipment, there are some areas that still need investigation. In the next section we will look at what the aerospace industry is doing with EMI/EMC and how digital twins can help during the design phase and provide support during certification.

There is a clear need for a broad, multifunctional toolset for electromagnetic engineering that can seamlessly link design and analysis digital twins throughout the development cycle. Once validated, these digital twins live on in PLM ecosystems and mobility chains, facilitating seamless product updates and autonomous driving data base enhancements.

By using such a toolset, engineers can not only obtain a more optimal solution, but they can gain precious time compared to current processes. Taking a holistic approach with a multifunctional and a broad toolset facilitates the seamless integration of electromagnetic applications into the overall design and development process. This results in more efficient, sustainable and better optimized products from complex airplanes and self-driving automobiles to connected consumer goods.

Multifunctional toolset for electromagnetic engineering

Simcenter 3D v19.2 has newly integrated electromagnetic simulations so that engineering teams can work in closer collaboration to address these challenges. The Electromagnetics modules include a low frequency solver from Simcenter™ MAGNET™ and a high-frequency solver for wave propagation class of problems.

This augments the existing toolset for electromagnetic engineering: Simcenter SPEED™ & Simcenter™ Motorsolve™ which are uniquely for electric motor design and the specialized Simcenter Star-CCM CFD-EM simulations. ■

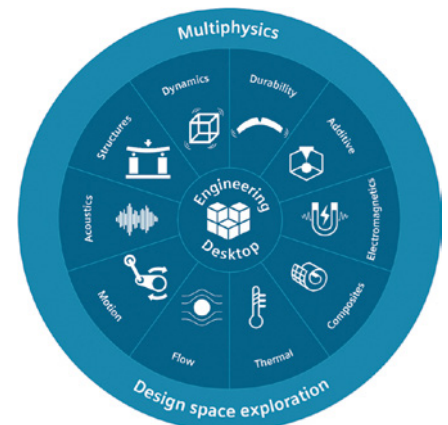

Figure 5: Expanding the multiphysics domain in Simcenter 3D with the Electromagnetics module

Join our Geek Hub!

Are you passionate about Engineering?

Have you used your engineering skills to make something cool or fix a common problem?

If so, send it into the Geek Hub and you could be featured in the next issue of Engineer Innovation

Send your story and pictures to nastasha.antunes@siemens.com



Every July, Horticultural Society Flowers turned upside down. The usually quiet little town is transformed into a gardener's haven. Quirky touches along with beautiful planting covers every available space. When Ray Edwards, founder of Limbicare, informed Debbie Searle, Marketing Specialist at Mentor, A Siemens Business, that Limbicare were going to be at this year's event, she championed a petition for Siemens to become a Gold sponsor of the Limbicare stand. Aside from supporting a really good cause, this event gave us a really good opportunity to learn how technology can actually enrich lives.

Debbie lost her leg in 2015 due to complications when she contracted Strep A. Later that year, with a lot of hard work, she was up and walking on a prosthetic with a mechanical knee joint. These prostheses work well, but the big problem with them is that there is a very high risk of falling. Unless you land your stride in the perfect position, the knee has no resistance and will collapse, leaving the wearer on the floor.

Just over two years later Debbie progressed to a micro-processor knee. These sophisticated knees house a PCB, battery, sensors and a resistance mechanism. The software analyzes the motion and speed of the wearer and is able to adjust the resistance to give the

more... Before setting on her... prosthetic was trialed, the first... was far too heavy. The knee alone... 1.5kg thus making her prosthetic leg weigh just over 6kg.

The second knee trialed was much lighter and allowed her to make the most of the features provided by the micro-processor. The knee analyzes gait and works out what the knee is required to do. It allows Debbie to walk at whatever speed she needs and catches her if she stumbles. It also recognizes if she is walking on slopes and ramps the resistance up or down. The brain behind all of this is powerful and working team constantly. The engineering team wanted to see exactly how hard it was working and if that affected the performance of the prosthetic as a whole.

Mike Gruetzmacher is the Simcenter FLOEFD Software Specialist for Mentor. Mike created a model using the hardware and technical details provided by Debbie, and additional new questions put to her due to never



Geek Hub

This time...Frying an Egg on
By James Forsyth, Engineering intern, Mentor
Business



Mike had... with a lid... results... to rise... would...
When... mis... we... b... r...

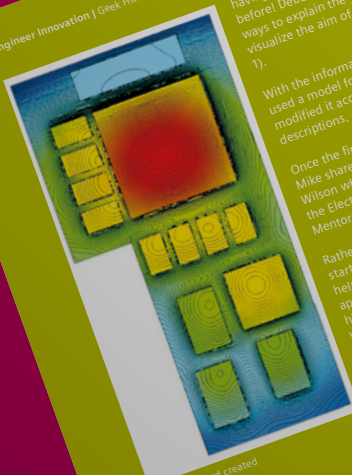

Figure 2: Board created

having to deal with a prosthetic leg before! Debbie found very innovative ways to explain the geometry and help visualize the aim of the project (Figure 1).

With the information gathered, Mike used a model found on GRABCAD and modified it according to Debbie's descriptions.

Once the first version was useable, Mike shared this model with John Wilson who created the PCB. John is the Electronics Product Specialist at the Electronics Business.

Rather than starting from MCAD, John started with an image and with the help of Debbie, determined the approximate scales of the board and with electronics that are battery powered there is a need to develop a solution that meets the lowest power requirements possible. In these situations the critical IC components are well within their temperature requirements (reliability of electronics are strongly related to both peak operating temperatures and temperature cycling). Thermal design often involves ensuring that any exposed surfaces that may be touched

are cool enough to eliminate the risk of injury. Many times the design requirements for the outer surface temperature are limited by how hot the surface feels. If a surface feels too warm, the end user could interpret this as a malfunctioning or poorly designed unit.

Mike took a GrabCAD example and performed some modifications until it looked more like the physical board. He also applied some scaling features, because the initial unit was smaller. The IDF file was imported into Simcenter FLOEFD with the Simcenter Flotherm FloEDA Bridge so that the boundary conditions (materials, heat sources and radiative surfaces) were created automatically, see Figure 3. The ambient conditions were set to typical values of 20°C and 1.01 bar. Gravity is enabled because it is cooled by natural convection.

The colored surfaces show the temperature distribution on the PCB. The arrows illustrate the airflow around these components. It is caused by the natural convection, which means the heated air moves upwards causing air circulation in this area. The air is escaping out through the top, but as our physical example has a lid,

a CPU!

or, a Siemens

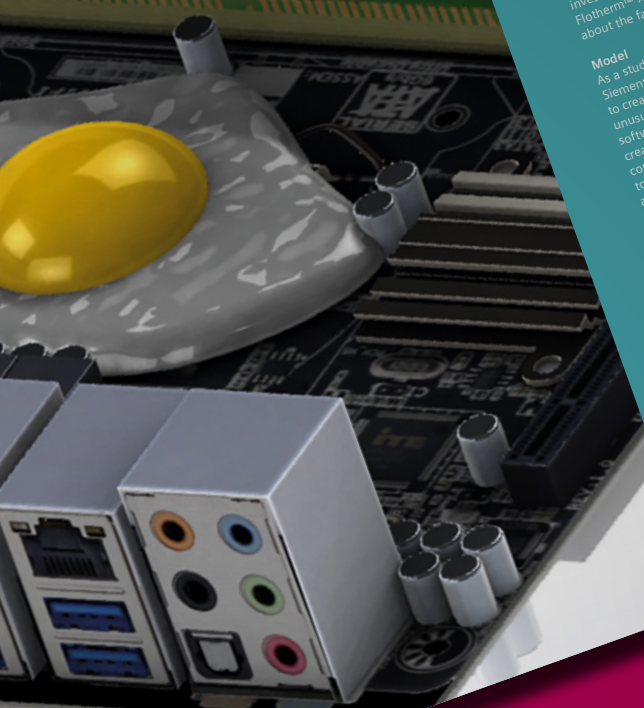

Figure 2: Temperature against time for egg cooled CPU

Solving complex thermal models with CFD requires a lot of processing power and a CPU under full load generates a fair amount of heat. But can you cook an egg on it? Search online and you can find videos of people attempting to cook on their processors, but how effective as a cooling solution is that? Before you throw away your conventional heatsink and fan, in favor of a multifunctional omelette, we'll investigate what CFD in Simcenter Flotherm XT software can predict about the fate of your PC if you do so.

Model

As a student intern at Mentor, a Siemens Business, I get the opportunity to create and play with interesting and unusual thermal models made in the software. For this concept, I started by creating a very basic model, comprising two cuboids and a cylinder to model a motherboard, processor and egg. Then I did some research – standard dimensions for motherboards, and egg. Then I did some research – CPU thermal design power (TDP), thermal data for eggs.

Using this very simple model, I was able to test things rapidly, get a rough feel for the range of temperatures and evaluate how feasible the concept was to model.

I then created a more detailed model, starting by importing a board using FLOEDA Bridge, a tool in Simcenter Flotherm XT that allows 3D CAD geometry to be produced from an intuitive 2D EDA environment. Using a representative MITX motherboard and a selection of known dimensions, I was able to accurately scale the image as a

texture onto the board. This allowed the footprints of the board components to be positioned accurately against the image.

An excessively detailed board is not necessary for this model as we are only interested in the CPU temperature. To do this, the model needs to include the major sources of heat and any geometry that may alter the flow of air around critical components. The geometry around the CPU, such as the CPU socket, needs to be much more detailed as this has a significant effect on heat transfer by conduction. The CPU itself is modeled with accurate geometry and a two-resistor network assembly thermal model, based on an Intel Core i3-4130 as a representative model. Typical range desktop processor, Intel Core i3-4130 and 72°C. The geometry far from the CPU, such as the I/O ports, can be modeled as simple cuboids that will present an obstacle to air flow on that edge of the board. Additional details would just prolong the solver computation time with diminutive improvement in accuracy.

Limitations

One consideration is that the egg cannot quite be simplified to a material with thermal properties independent of temperature, which Flotherm XT is easily capable of modeling. For instance, apply heat to a block of aluminum and that energy will all eventually be transferred to the ambient air



to create another simulation to see how this changed the temperature. We expected to wait to see if this was a drastic increase:

Mike realized there was a lid missing from the model and the air was escaping through the top, he went back into the geometry, selected the open plane and with a few quick clicks created a lid to close the simulation, he obtained very high and unrealistic temperatures. As he was making a quick simulation as an insulator material. He also experimented by putting a heatsink on the PCB, and for this comparison the parts was neglected, for some of the top of the leg properties

Now that the influence of the closed top with the combination of the closed top with insulator material, caused the high temperature was run for both cases with simulation as standard stainless steel. The maximum temperature is almost equal in both cases, it shows only a very small difference. What does this mean? Most of the heat is connecting and radiating from the PCB to the outer enclosure.

In summary, putting on a lid and enclosing the casing makes minimal impact. The maximum temperatures reached in either case is 38°C. So at maximum advised temperature in a consumer product is around 41°C. So at a little over body temperature, Debbie's leg, even while working at its hardest,

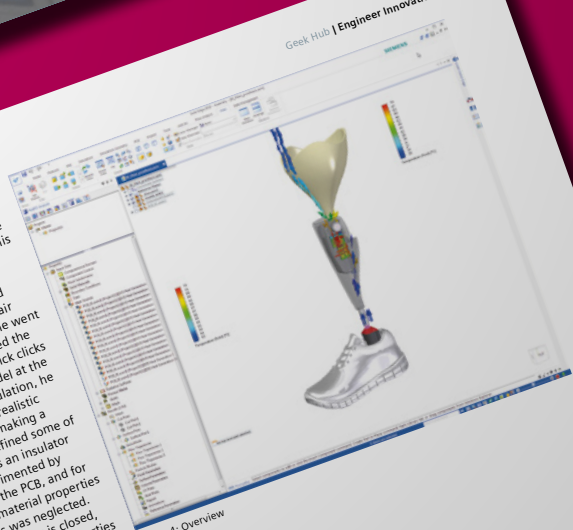
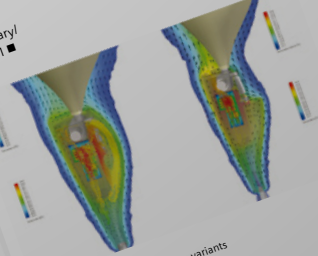

Figure 4: Overview

should not cause any burns or discomfort. The information that can be gathered is invaluable, without having to build multiple prototypes or having to redesign later on in the design process.

For more information:
www.limbcare.org
Debbie Searle Blog:
<https://bit.ly/2JJCz7V>

References
[1] <https://grabcad.com/library/below-knee-prosthesis-1>



Comparison of the two variants

as it cools. Do the same to an egg and not all of the energy will be transferred to the ambient; cooking an egg is an endothermic process and a proportion of the energy will be converted to the change in chemical enthalpy of the egg as it cooks. [2]

So the question is: how significant is this lost cooking energy to our model? Well, after some research and calculations, to denature the egg proteins enthalpy is around 2.7 J/g for egg yolk, [3,4] during cooking is around 1.0 J/g egg, the total energy required is only around 80J, so for an average 50 g egg, the total energy required to contribute to a total of approximately 6°C, but this removal of energy in CPU temperature of approximately 54 W TDP [1] of a CPU under full load, after a few minutes of cooking, the heat can only dissipate through the action of the mitigating air flow.

The majority of the heat is absorbed by the water – slightly higher density than the yolk (increasing with temperature) and the specific heat capacities of 3.55-3.60 J/(g K) and 1.8 J/(g K) respectively. The white; thermal conductivities of 0.550-0.558 W/(m K) for the yolk and 0.389-0.407 W/(m K) for the white (decreasing with temperature). The actual values used in the model were based on a moving average of reported experimental data. [5].

Another factor not considered in the model is water in the egg heating up to steam which rises, carrying away heat, though this is in small enough quantities compared to the flow of surrounding air that it can be ignored for now.

These two modeling limitations mean that the results are likely to be a slight overestimation of the temperatures. The egg is a complex structure, the worst case scenario, the case where the egg is a solid, the case where the egg is a liquid, the case where the egg is a gas, the case where the egg is a plasma, the case where the egg is a black hole.

Results Unfortunately, the temperatures reached in either case is 38°C. So at maximum advised temperature in a consumer product is around 41°C. So at a little over body temperature, Debbie's leg, even while working at its hardest,



Figure 4: Particle plot showing a comparison of two variants

Brownian Motion...

The random musings of a Fluid Dynamicist

Where's my ducky?

In January 1992 a cargo ship heading from China to the US encountered a terrible ocean storm. As the wind and rain lashed the deck, and as the ship rocked back and forth on freakish waves, a cargo crate worked free of its tethers and, almost unnoticed, slid off the deck and into the Pacific Ocean.

That crate contained no less than 29,000 plastic toys, a disparate collection of crabs, beavers, frogs and small yellow ducks. Originally destined to spend their lives in the warm and safe environment of an American bathtub, this bath toys, was instead destined to spend the next 27 years navigating the ocean currents, on an epic journey around the world.

And what a journey. Being swept along at an average speed of almost 7 miles per day (twice as fast as the ocean current), some of the ducks have traveled over 50,000 nautical miles. Survivors of this avian flotilla were recovered in far-flung locations such as Australia, Japan, North America, South America and Europe. Almost three decades later, these battered bath toys are still washing up on beaches around the world: bleached by sun and seawater, the ducks and beavers had faded to white, but the turtles and frogs had kept their original colors. Some intrepid ducks have even visited the North Pole after becoming frozen in an Arctic ice-stream.

Unsurprisingly, the plight of these ducks **aroused much interest** in the scientific and engineering community, who have tracked progress of their epic journey, in one of the world's biggest validation exercises. It is **well reported** that the duck flotilla has greatly **enhanced our understanding of ocean currents**, as teams of dedicated oceanographers track the progress of the ducks and try to predict where they will end up next.

What is much less well known, is that incident inspired a whole new engineering discipline of "predictive-toy-duck-hydrodynamics", in which highly qualified engineers **dedicated** wasted a significant amount of effort and **utilized** abused computational fluid dynamics software to simulate how a duck would respond to extreme wave conditions in the ocean. Brownian Motion was definitely not one of them! ■

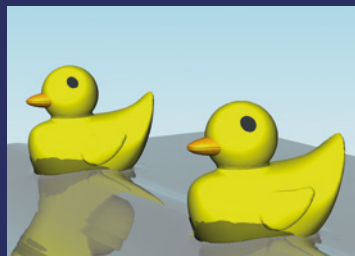

Route taken by the Duck Flotilla initially lost in the Pacific Ocean in 1992. (NordNordWest via Wikimedia Commons)

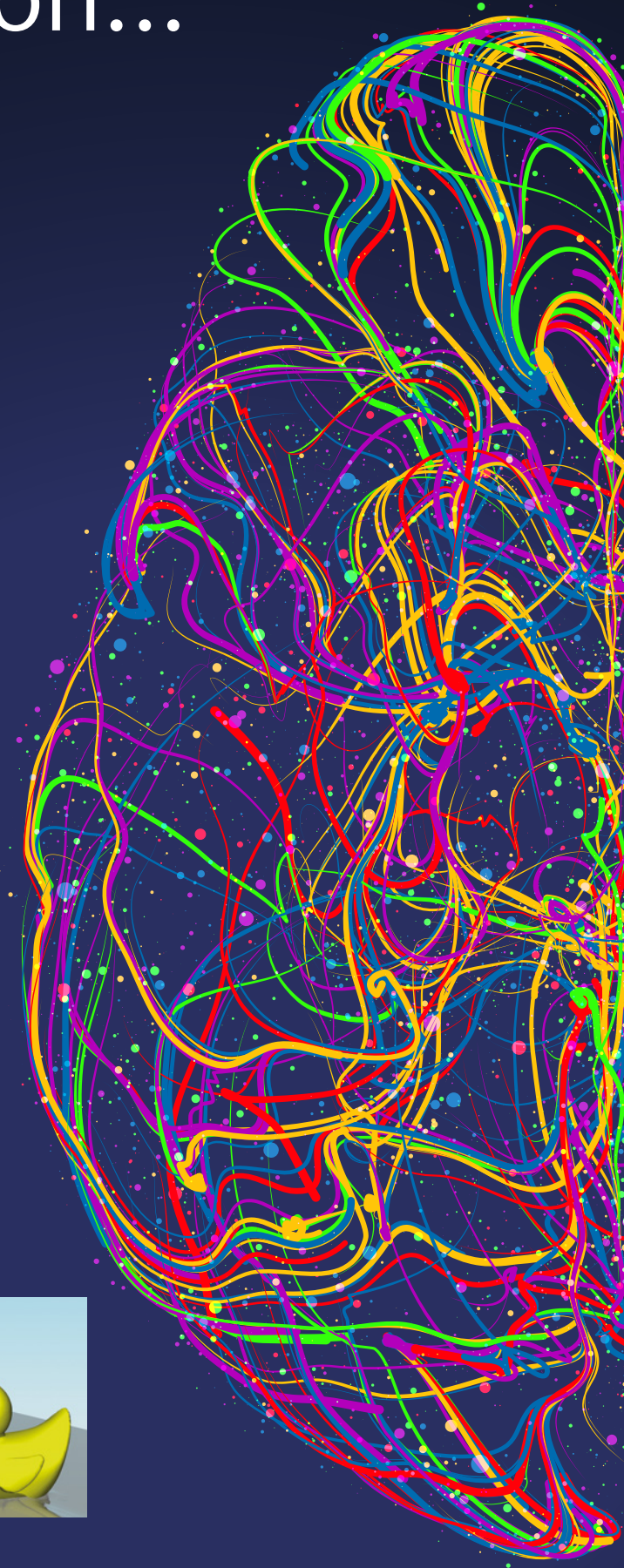

SIEMENS

Ingenuity for life

Siemens Digital Industries Software

The future of engineering

Register for
the 2019
Simcenter
conference



Join us for the 2019 Simcenter Conference
2nd – 4th December 2019
Mövenpick Hotel, Amsterdam City Centre

[siemens.com/simcenter](https://www.siemens.com/simcenter)

Director of publication: Peter De Clerck

Editor-in-chief: Natasha Antunes

Although we make every effort to ensure the accuracy of Engineer Innovation, we cannot be held liable for incorrect information.

© 2019 Siemens Product Lifecycle Management Software Inc.

78451-01 08/19

